

# Leica 3D Disto



3D Disto Software  
for Windows®

Swiss Technology  
by Leica Geosystems

User Manual  
Version 6.1  
English

- when it has to be **right**

*Leica*  
Geosystems

PART OF  
HEXAGON

# Introduction

## Purchase

Congratulations on the purchase of the Leica 3D Disto.



This manual contains important safety directions as well as instructions for setting up the product and operating it. Refer to [1 Safety Directions](#) for further information.

Read carefully through the User Manual before you switch on the product.

## Product identification



The model and serial number of your product are indicated on the type plate. Always refer to this information when you need to contact your agency or Leica Geosystems authorised service centre.

## Trademarks

- Windows® is a registered trademark of Microsoft Corporation in the United States and other countries

All other trademarks are the property of their respective owners.

## Available Documentation

Name	Description/Format		
3D Disto Quick Start	Intended as quick reference guide for first setup.	✓	✓
3D Disto User Manual	All instructions required in order to operate the instrument at a basic level are contained in this User Manual. Provides an overview of the instrument together with technical data and safety directions.	-	✓
Safety Manual	Provides important safety instructions for use of 3D Disto.	✓	✓

### Refer to the following resources for all 3D Disto documentation/software:

- Leica USB memory stick
- <https://myworld.leica-geosystems.com>

## Leica Geosystems address book

On the last page of this manual, you can find the address of Leica Geosystems headquarters. For a list of regional contacts, please visit [http://leica-geosystems.com/contact-us/sales\\_support](http://leica-geosystems.com/contact-us/sales_support).



myWorld@Leica Geosystems (<https://myworld.leica-geosystems.com>) offers a wide range of services, information and training material.

With direct access to myWorld, you are able to access all relevant services whenever it is convenient for you.

Service	Description
myProducts	Add all products that you and your company own and explore your world of Leica Geosystems: View detailed information on your products and update your products with the latest software and keep up-to-date with the latest documentation.
myService	View the current service status and full service history of your products in Leica Geosystems service centres. Access detailed information on the services performed and download your latest calibration certificates and service reports.
mySupport	Create new support requests for your products that will be answered by your local Leica Geosystems Support Team. View the complete history of your support requests and view detailed information on each request in case you want to refer to previous support requests.
myTraining	Enhance your product knowledge with Leica Geosystems Campus - Information, Knowledge, Training. Study the latest online training material on your products and register for seminars or courses in your country.
myTrustedServices	Add your subscriptions and manage users for Leica Geosystems Trusted Services, the secure software services, that assist you to optimise your workflow and increase your efficiency.

# Table of Contents

<b>1</b>	<b>Safety Directions</b>	<b>6</b>
1.1	General Introduction	6
1.2	Definition of Use	7
1.3	Limits of Use	7
1.4	Responsibilities	7
1.5	Hazards of Use	8
1.6	Laser Classification	10
	1.6.1 General	10
	1.6.2 Integrated Distance Meter	11
1.7	Electromagnetic Compatibility (EMC)	11
1.8	Conformity to National Regulations	13
	1.8.1 FCC Statement, Applicable in U.S.	13
	1.8.2 ISED Statement, Applicable in Canada	14
	1.8.3 Japanese Radio Law Compliance	14
	1.8.4 Singapore	14
1.9	Labelling	15
<b>2</b>	<b>Description of the System</b>	<b>16</b>
2.1	Overview	16
2.2	Container Contents	16
2.3	Instrument Components	17
	2.3.1 3D Disto	17
	2.3.2 RM100 Remote Control	19
2.4	Power Supply	19
2.5	3D Disto Software	20
	2.5.1 Software Concept	20
	2.5.2 User Interface	21
<b>3</b>	<b>Instrument Setup</b>	<b>27</b>
3.1	Setting Up 3D Disto	27
3.2	Connecting the 3D Disto to a Windows Device	27
3.3	Assistant	28
3.4	Tilt Sensor	29
3.5	Device Configuration and Menu Settings	29
3.6	Data Management	30
	3.6.1 File Manager	30
	3.6.2 Export and Import of Data	32
3.7	Calculator	32
<b>4</b>	<b>Technical Terms and Abbreviations</b>	<b>34</b>
<b>5</b>	<b>Operation</b>	<b>38</b>
5.1	Measurements	38
5.2	Using Layers	38
5.3	Pointfinder	39
5.4	Measurement Workflow	42
<b>6</b>	<b>Software Applications</b>	<b>46</b>
6.1	Overview	46
6.2	Measure	46
	6.2.1 Reference Height	46
	6.2.2 Scan Tool for Automated Scans	47
	6.2.3 CAD Tools	50
6.3	Projector	62
	6.3.1 Workflow	63
	6.3.2 Targeting and Layout with RM100 Remote Control	66

6.4	Location	66
6.5	Tool Kit	69
6.5.1	Comfort Plumbing	69
6.5.2	Comfort Targeting	70
6.5.3	Comfort Level	71
6.5.4	Meter Mark	71
6.5.5	Height Tracking	72
6.5.6	Parallel Line	73
<b>7</b>	<b>Error Messages</b>	<b>75</b>
<b>8</b>	<b>Check &amp; Adjust</b>	<b>77</b>
8.1	Overview	77
8.2	Tilt Sensor Calibration	77
8.3	Crosshairs Offset	78
8.4	V-Index Error	79
8.5	Reset to Factory Settings	80
<b>9</b>	<b>Instrument Protection (Theft Protection)</b>	<b>81</b>
<b>10</b>	<b>Care and Transport</b>	<b>82</b>
10.1	Transport	82
10.2	Storage	82
10.3	Cleaning and Drying	83
<b>11</b>	<b>Technical Data</b>	<b>84</b>
11.1	Technical Data	84
11.2	Conformity to National Regulations	85
11.3	Dangerous Goods Regulations	86
<b>12</b>	<b>Warranty</b>	<b>87</b>
<b>13</b>	<b>Software Licence Agreement</b>	<b>88</b>

# 1 Safety Directions

## 1.1 General Introduction

### Description

The following directions enable the person responsible for the product, and the person who actually uses the equipment, to anticipate and avoid operational hazards.

The person responsible for the product must ensure that all users understand these directions and adhere to them.

### About warning messages





Warning messages are an essential part of the safety concept of the instrument. They appear wherever hazards or hazardous situations can occur.

#### Warning messages...

- make the user alert about direct and indirect hazards concerning the use of the product.
- contain general rules of behaviour.

For the users' safety, all safety instructions and safety messages shall be strictly observed and followed! Therefore, the manual must always be available to all persons performing any tasks described here.

**DANGER, WARNING, CAUTION** and **NOTICE** are standardised signal words for identifying levels of hazards and risks related to personal injury and property damage. For your safety, it is important to read and fully understand the following table with the different signal words and their definitions! Supplementary safety information symbols may be placed within a warning message as well as supplementary text.

Type	Description
 <b>DANGER</b>	Indicates an imminently hazardous situation which, if not avoided, will result in death or serious injury.
 <b>WARNING</b>	Indicates a potentially hazardous situation or an unintended use which, if not avoided, could result in death or serious injury.
 <b>CAUTION</b>	Indicates a potentially hazardous situation or an unintended use which, if not avoided, may result in minor or moderate injury.
<b>NOTICE</b>	Indicates a potentially hazardous situation or an unintended use which, if not avoided, may result in appreciable material, financial and environmental damage.
	Important paragraphs which must be adhered to in practice as they enable the product to be used in a technically correct and efficient manner.

## 1.2

### Definition of Use

---

#### Intended Use

- 3D measuring of distances, heights, grades, angles, area and volume.
  - Manual and automatic measurement of room dimensions.
  - Automatic measurement of profiles.
  - Laying out points and designs, for example from blueprint.
  - Generation of drawings.
  - Camera functionality.
  - Import/Export of data.
  - Administration of data.
- 

#### Reasonably foreseeable misuse

- Use of the product without instruction.
  - Use outside of the intended use and limits.
  - Disabling safety systems.
  - Removal of hazard notices.
  - Opening the product using tools, for example screwdriver, unless this is permitted for certain functions.
  - Modification or conversion of the product.
  - Use after misappropriation.
  - Use of products with recognisable damage or defects.
  - Use with accessories from other manufacturers without the prior explicit approval of Leica Geosystems.
  - Inadequate safeguards at the working site.
  - Deliberate dazzling of third parties.
  - Controlling of machines, moving objects or similar monitoring application without additional control and safety installations.
- 

## 1.3

### Limits of Use

---

#### Environment

Suitable for use in an atmosphere appropriate for permanent human habitation: not suitable for use in aggressive or explosive environments.

---

#### **WARNING**

#### **Working in hazardous areas, or close to electrical installations or similar situations**

Life Risk.

#### **Precautions:**

- ▶ Local safety authorities and safety experts must be contacted by the person responsible for the product before working in such conditions.
- 

## 1.4

### Responsibilities

---

#### Manufacturer of the product

Leica Geosystems AG, CH-9435 Heerbrugg, hereinafter referred to as Leica Geosystems, is responsible for supplying the product, including the User Manual and original accessories, in a safe condition.

---

## Person responsible for the product

The person responsible for the product has the following duties:

- To understand the safety instructions on the product and the instructions in the User Manual.
- To ensure that it is used in accordance with the instructions.
- To be familiar with local regulations relating to safety and accident prevention.
- To inform Leica Geosystems immediately if the product and the application becomes unsafe.
- To ensure that the national laws, regulations and conditions for the operation of the product are respected.

## 1.5

### Hazards of Use

#### NOTICE

#### **Dropping, misusing, modifying, storing the product for long periods or transporting the product**

Watch out for erroneous measurement results.

#### **Precautions:**

- ▶ Periodically carry out test measurements, particularly after the product has been subjected to abnormal use and before and after important measurements.

#### **WARNING**

#### **Distraction/loss of attention**

During dynamic applications, for example stakeout procedures, there is a danger of accidents occurring if the user does not pay attention to the environmental conditions around, for example obstacles, excavations or traffic.

#### **Precautions:**

- ▶ The person responsible for the product must make all users fully aware of the existing dangers.

#### **WARNING**

#### **Inadequate securing of the working site**

This can lead to dangerous situations, for example in traffic, on building sites and at industrial installations.

#### **Precautions:**

- ▶ Always ensure that the working site is adequately secured.
- ▶ Adhere to the regulations governing safety, accident prevention and road traffic.



## CAUTION

### **Not properly secured accessories**

If the accessories used with the product are not properly secured and the product is subjected to mechanical shock, for example blows or falling, the product may be damaged or people can sustain injury.

#### **Precautions:**

- ▶ When setting up the product, make sure that the accessories are correctly adapted, fitted, secured, and locked in position.
  - ▶ Avoid subjecting the product to mechanical stress.
- 

## WARNING

### **Inappropriate mechanical influences to batteries**

During the transport, shipping or disposal of batteries it is possible for inappropriate mechanical influences to constitute a fire hazard.

#### **Precautions:**

- ▶ Before shipping the product or disposing it, discharge the batteries by the product until they are flat.
  - ▶ When transporting or shipping batteries, the person in charge of the product must ensure that the applicable national and international rules and regulations are observed.
  - ▶ Before transportation or shipping, contact your local passenger or freight transport company.
- 

## WARNING

### **Exposure of batteries to high mechanical stress, high ambient temperatures or immersion into fluids**

This can cause leakage, fire or explosion of the batteries.

#### **Precautions:**

- ▶ Protect the batteries from mechanical influences and high ambient temperatures. Do not drop or immerse batteries into fluids.
- 

## WARNING

### **Short circuit of battery terminals**

If battery terminals are short circuited e.g. by coming in contact with jewellery, keys, metallised paper or other metals, the battery can overheat and cause injury or fire, for example by storing or transporting in pockets.

#### **Precautions:**

- ▶ Make sure that the battery terminals do not come into contact with metallic objects.
-

## **WARNING**

### **Improper disposal**

If the product is improperly disposed of, the following can happen:

- If polymer parts are burnt, poisonous gases are produced which may impair health.
- If batteries are damaged or are heated strongly, they can explode and cause poisoning, burning, corrosion or environmental contamination.
- By disposing of the product irresponsibly you may enable unauthorised persons to use it in contravention of the regulations, exposing themselves and third parties to the risk of severe injury and rendering the environment liable to contamination.

#### **Precautions:**



The product must not be disposed with household waste. Dispose of the product appropriately in accordance with the national regulations in force in your country. Always prevent access to the product by unauthorised personnel.

Product-specific treatment and waste management information can be received from your Leica Geosystems distributor.

## **CAUTION**

Changes or modifications not expressly approved by Leica Geosystems for compliance could void the user's authority to operate the equipment.

## **WARNING**

### **Improperly repaired equipment**

Risk of injuries to users and equipment destruction due to lack of repair knowledge.

#### **Precautions:**

- ▶ Only authorised Leica Geosystems Service Centres are entitled to repair these products.

## **1.6**

## **Laser Classification**

### **1.6.1**

### **General**

#### **General**

The following chapters provide instructions and training information about laser safety according to international standard IEC 60825-1 (2014-05) and technical report IEC TR 60825-14 (2004-02). The information enables the person responsible for the product and the person who actually uses the equipment, to anticipate and avoid operational hazards.



According to IEC TR 60825-14 (2004-02), products classified as laser class 1, class 2 and class 3R do not require:

- laser safety officer involvement,
- protective clothes and eyewear,
- special warning signs in the laser working area

if used and operated as defined in this User Manual due to the low eye hazard level.



National laws and local regulations could impose more stringent instructions for the safe use of lasers than IEC 60825-1 (2014-05) and IEC TR 60825-14 (2004-02).

## 1.6.2

### Integrated Distance Meter

#### Integrated Distance Meter

The Leica 3D Disto produces a visible laser beam which emerges from the front of the instrument.

The laser product described in this section is classified as laser class 2 in accordance with:

- IEC 60825-1 (2014-05): "Safety of laser products"

These products are safe for momentary exposures but can be hazardous for deliberate staring into the beam. The beam may cause dazzle, flash-blindness and after-images, particularly under low ambient light conditions.

Description	Value
Wavelength	620 nm - 690 nm
Maximum average radiant power	<1 mW
Pulse repetition frequency	320 MHz
Pulse duration	<1 ns
Beam divergence	0.16 mrad × 0.6 mrad

#### CAUTION

##### Class 2 laser product

From a safety perspective, class 2 laser products are not inherently safe for the eyes.

##### Precautions:

- ▶ Avoid staring into the beam or viewing it through optical instruments.
- ▶ Avoid pointing the beam at other people or at animals.

## 1.7

### Electromagnetic Compatibility (EMC)

#### Description

The term Electromagnetic Compatibility is taken to mean the capability of the product to function smoothly in an environment where electromagnetic radiation and electrostatic discharges are present, and without causing electromagnetic disturbances to other equipment.

#### WARNING

##### Electromagnetic radiation

Electromagnetic radiation can cause disturbances in other equipment.

##### Precautions:

- ▶ Although the product meets the strict regulations and standards which are in force in this respect, Leica Geosystems cannot completely exclude the possibility that other equipment may be disturbed.
- ▶ The product is a class A product when operated with the internal batteries. In a domestic environment this product may cause radio interference in which case the user may be required to take adequate measures.

 **CAUTION**

**Use of the product with accessories from other manufacturers. For example field computers, personal computers or other electronic equipment, non-standard cables or external batteries**

This may cause disturbances in other equipment.

**Precautions:**

- ▶ Use only the equipment and accessories recommended by Leica Geosystems.
- ▶ When combined with the product, they meet the strict requirements stipulated by the guidelines and standards.
- ▶ When using computers, two-way radios or other electronic equipment, pay attention to the information about electromagnetic compatibility provided by the manufacturer.

 **CAUTION**

**Intense electromagnetic radiation. For example, near radio transmitters, transponders, two-way radios or diesel generators**

Although the product meets the strict regulations and standards which are in force in this respect, Leica Geosystems cannot completely exclude the possibility that function of the product may be disturbed in such an electromagnetic environment.

**Precautions:**

- ▶ Check the plausibility of results obtained under these conditions.

 **CAUTION**

**Electromagnetic radiation due to improper connection of cables**

If the product is operated with connecting cables attached at only one of their two ends, for example external supply cables, interface cables, the permitted level of electromagnetic radiation may be exceeded and the correct functioning of other products may be impaired.

**Precautions:**

- ▶ While the product is in use, connecting cables, for example product to external battery, product to computer, must be connected at both ends.

## **WARNING**

### **Use of product with radio or digital cellular phone devices**

Electromagnetic fields can cause disturbances in other equipment, in installations, in medical devices, for example pacemakers or hearing aids and in aircrafts. Electromagnetic fields can also affect humans and animals.

#### **Precautions:**

- ▶ Although the product meets the strict regulations and standards which are in force in this respect, Leica Geosystems cannot completely exclude the possibility that other equipment can be disturbed or that humans or animals can be affected.
- ▶ Do not operate the product with radio or digital cellular phone devices in the vicinity of filling stations or chemical installations, or in other areas where an explosion hazard exists.
- ▶ Do not operate the product with radio or digital cellular phone devices near to medical equipment.
- ▶ Do not operate the product with radio or digital cellular phone devices in aircrafts.
- ▶ Do not operate the product with radio or digital cellular phone devices for long periods with the product immediately next to your body.

---

## **1.8**

### **Conformity to National Regulations**

---

#### **1.8.1**

#### **FCC Statement, Applicable in U.S.**

## **WARNING**

This equipment has been tested and found to comply with the limits for a Class B digital device, pursuant to part 15 of the FCC rules.

These limits are designed to provide reasonable protection against harmful interference in a residential installation.

This equipment generates, uses and can radiate radio frequency energy and, if not installed and used in accordance with the instructions, may cause harmful interference to radio communications. However, there is no guarantee that interference will not occur in a particular installation.

If this equipment does cause harmful interference to radio or television reception, which can be determined by turning the equipment off and on, the user is encouraged to try to correct the interference by one or more of the following measures:

- Reorient or relocate the receiving antenna.
- Increase the separation between the equipment and the receiver.
- Connect the equipment into an outlet on a circuit different from that to which the receiver is connected.
- Consult the dealer or an experienced radio/TV technician for help.



---

This device complies with part 15 of the FCC Rules. Operation is subject to the following two conditions:

1. This device may not cause harmful interference, and
  2. This device must accept any interference received, including interference that may cause undesired operation.
-

## FCC Radiation Exposure Statement

The radiated output power of the instrument is far below the FCC radio frequency exposure limits. Nevertheless, the instrument should be used in such a manner that the potential for human contact during normal operation is minimized. To avoid the possibility of exceeding the FCC radio frequency exposure limits, keep a distance of at least 20 cm between you (or any other person in the vicinity) and the antenna that is built into the instrument.

### 1.8.2

#### ISED Statement, Applicable in Canada

##### WARNING

This device complies with Industry Canada's licence-exempt RSSs. Operation is subject to the following two conditions:

1. This device may not cause interference; and
2. This device must accept any interference, including interference that may cause undesired operation of the device.

## Radio Frequency (RF) Exposure Compliance Statement

The radiated RF output power of the instrument is below the Health Canada's Safety Code 6 exclusion limit for portable devices (radiated element separation distance between the radiating element and user and/or bystander is below 20 cm).

### 1.8.3

#### Japanese Radio Law Compliance



Japanese Radio Law Compliance:

- This device is granted pursuant to the Japanese Radio Law (電波法).
- This device should not be modified (otherwise the granted designation number will become invalid).

### 1.8.4

#### Singapore



Leica 3D Disto:

Complies with  
IMDA Standards  
DB102875

Labelling 3D Disto

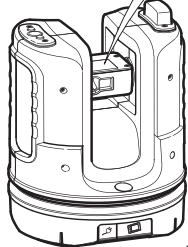

010747.003



Complies with 21 CFR 1040.10 and 1040.11 except for deviations pursuant to Laser Notice Nr.50, dated June 24, 2007  
IEC 60285-1:2014  
 $\lambda=620-690\text{nm}$   
 $P_{av}<1\text{mW}$   
 $t_p<1\text{ns}$



**Type: Leica 3D Disto**

Art.No.: 844709    Power: 24V $\overline{-}$  / 2.5A  
Contains IC: 5123A-BGTWF11  
Contains FCC ID: QQQWF11  
Patents: US 8279421, US 6864966, US 7030969, US 6859744, US 6463393  
This device complies with part 15 of the FCC Rules. Operation is subject to the following two conditions:  
(1) This device may not cause harmful interference, and  
(2) this device must accept any interference received, including interference that may cause undesired operation.

**SWISS Technology**  
by Leica Geosystems



Made in Singapore  
[www.leica-geosystems.com](http://www.leica-geosystems.com)

Labelling RM100 Remote Control

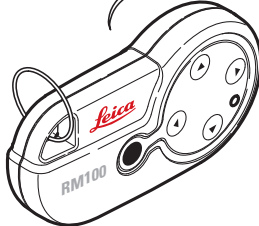

010748.001



**Type: RM100**  
Art.No.: 780994

Power: 1.5V $\overline{-}$  / 0.4A  
Leica Geosystems AG  
CH-9435 Heerbrugg  
Made in XXX



## 2

## Description of the System

### 2.1

### Overview

#### 3D Disto General Description

The Leica3D Disto is a three-dimensional measuring and projection system. To operate the 3D Disto you need a Windows device. To perform certain functions you can also use the RM100 Remote Control.

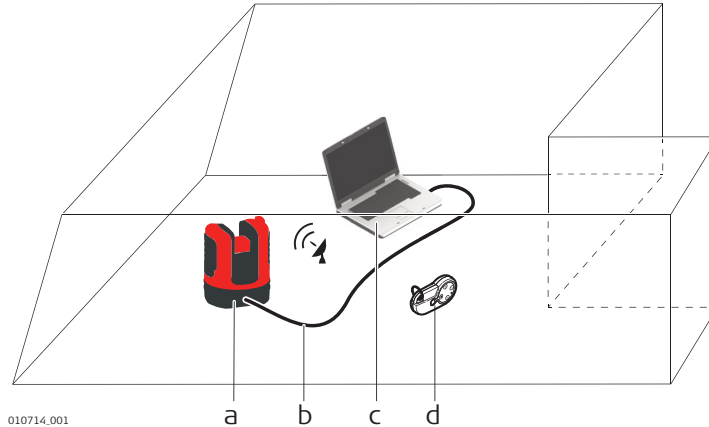

010714.001

- |   |           |   |   |
|---|-----------|---|---|
| a | 3D Disto  | c | Windows device (not part of the delivery) |
| b | USB Cable | d | RM100 Remote Control                      |

### 2.2

### Container Contents

#### Container Contents (1/2)

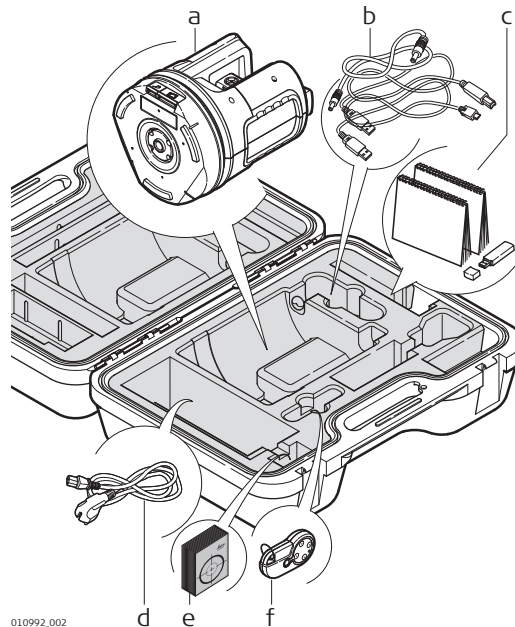

010992.002

- a 3D Disto with built-in SD WLAN card
- b USB connection cable 3D Disto to the Windows device
- c Safety Instructions Manual, 3D Disto Quick Start, CE and Producer Certificate, USB memory stick (with licence keys, User Manual, Windows software and setup information)
- d Four country-specific cables for 3D Disto power supply
- e Target marks, self-adhesive, 50 units in one bag
- f RM100 remote control and battery



**Container Contents  
(2/2)**

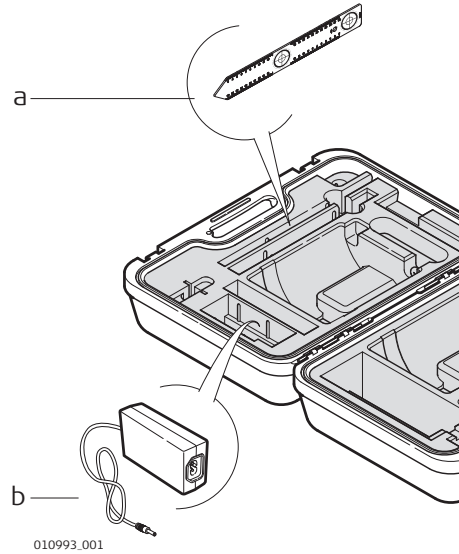

- a Ruler for offset points
- b 3D Disto power supply

**2.3 Instrument Components**

**2.3.1 3D Disto**

**Motor-driven Part**

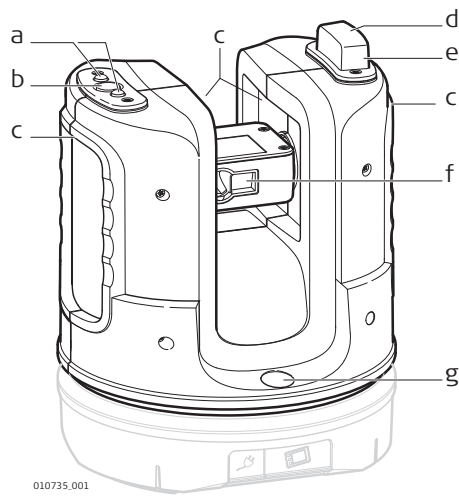

- a LEDs for 3D Disto status
- b ON/OFF button
- c Grips to hold the instrument
- d Infrared (IR) interface
- e WLAN interface
- f Laser distance meter with Pointfinder
- g Circular bubble

**Battery Socket**

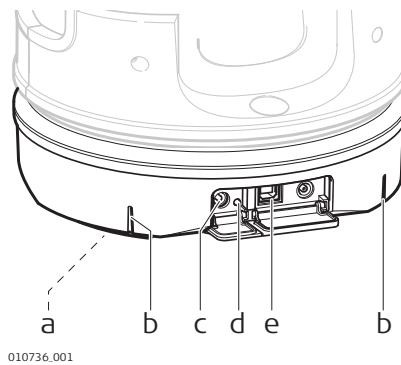

- a Tripod thread 5/8"
- b 90° marking
- c Power supply connector for 3D Disto
- d LED for battery status
- e Data cable connector

**LEDs and Buttons**

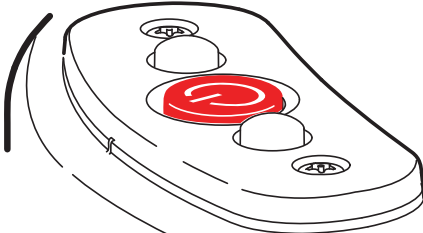
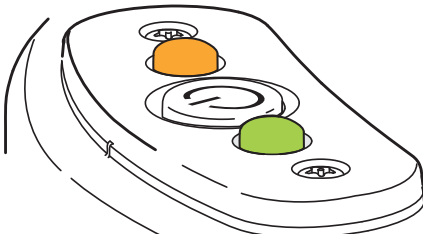
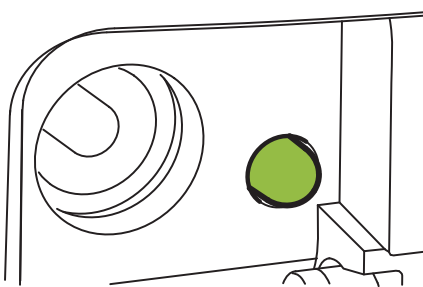
Button/LEDs	Description
<p>ON/OFF button</p>  <p>010732_001</p>	<p>Button to turn instrument ON or OFF. Instrument turns OFF after 15 minutes if not connected to the PC.</p>
<p>LEDs for 3D Disto status</p>  <p>010731_001</p>	<ul style="list-style-type: none"> <li>• Green and orange LEDs light up continuously: 3D Disto is booting.</li> <li>• Orange LED flashes: Self-levelling procedure is running or tilt &gt; 3°.</li> <li>• Green LED flashes: 3D Disto is ready for measurement. Tilt sensor is on.</li> <li>• Orange LED lights up continuously: An error occurred. Refer to <a href="#">7 Error Messages</a>.</li> <li>• Green and orange LEDs light up continuously: Press the ON button to reset the instrument.</li> </ul> <p>For experts only: Tilt sensor off Green LED flashes once; orange LED three times.</p>
<p>LED for battery status</p>  <p>010733_001</p>	<p>If instrument is on and connected to the charger:</p> <ul style="list-style-type: none"> <li>• Green LED flashes 1x: Battery is charged to 25%.</li> <li>• Green LED flashes 2x: Battery is charged to 50%.</li> <li>• Green LED flashes 3x: Battery is charged to 75%.</li> <li>• Green LED is on: Battery is fully charged.</li> </ul>

**LDM Laser**

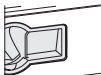
Status of Laser Beam	Description
 <p>010734_001</p> <p>OFF</p>	<p>Pointfinder is OFF or 3D Disto targets automatically.</p>
<p>ON</p>	<p>Pointfinder is ON or user is targeting by Remote Control.</p>
<p>Flashing</p>	<p>To indicate the precise position of a projected point.</p>

## 2.3.2

## RM100 Remote Control

### Remote Control Components

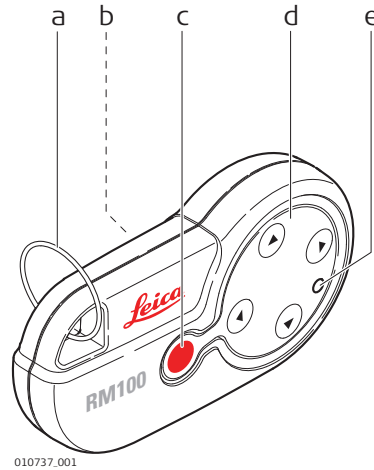

- a Key ring
- b Battery compartment
- c DIST button
- d Navigation buttons: Up/Down/Right/Left
- e Control LED

### Navigation Buttons

The RM100 Remote Control has five buttons that allow turning the 3D Disto and executing a distance measurement or point projection, depending on the application program running.

☞ The RM100 Remote Control does not support the Tool Kit applications.

#### Targeting Procedure

1. **Rough targeting:** hold ▲ / ▼ / ◀ / ▶ to turn the 3D Disto as long as key is pressed.
2. **Fine targeting:** short tap on ▲ / ▼ / ◀ / ▶ to turn the 3D Disto by small single steps.
3. **Measure:** Press ●.

## 2.4

### Power Supply

#### First-time use/ charging batteries

- The battery must be charged before using it for the first time because it is delivered with an energy content as low as possible.
- The permissible temperature range for charging is from 0 °C to +40 °C/+32 °F to +104 °F. For optimal charging, we recommend charging the batteries at a low ambient temperature of +10 °C to +20 °C/+50 °F to +68 °F if possible.
- It is normal for the battery to become warm during charging. Using the chargers recommended by Leica Geosystems, it is not possible to charge the battery once the temperature is too high.
- For new batteries or batteries that have been stored for a long time (> three months), it is effectual to make only one charge/discharge cycle.
- For Li-Ion batteries, a single discharging and charging cycle is sufficient. We recommend carrying out the process when the battery capacity indicated on the charger or on a Leica Geosystems product deviates significantly from the actual battery capacity available.

#### Operation / Discharging

- Batteries can operate from -10°C to +50°C/14°F to +122°F.
- Low operating temperatures reduce the capacity that can be drawn; high operating temperatures reduce the service life of the battery.

## 3D Disto Power Supply



Only Leica Geosystems authorised service workshops are entitled to replace the battery socket.

- **Internal:** by battery socket, with non-removable Li-Ion batteries, 14.4 V, 63 Wh.
- **External:** Power supply for 3D Disto connected by cable with country-specific plugs for worldwide use. Input: 100 - 240 V AC, 50/60 Hz. Output: 24 V DC, 2.5 A. Length: 1.80 m.

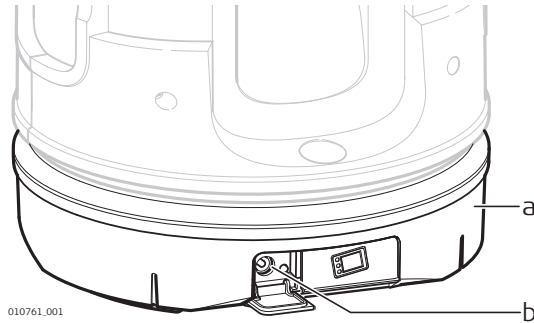

- a Battery socket
- b Power supply connector

## RM100 Remote Control Power Supply

The RM100 is equipped with one AA alkaline battery, 1.5 V.

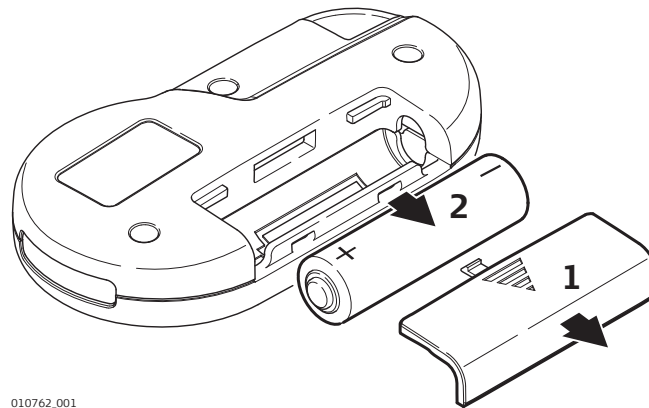

1. Push the battery cover in the direction of the arrow to open the battery compartment.
2. Replace the battery and refit the battery cover.

## 2.5

### 3D Disto Software

#### 2.5.1

#### Software Concept

### 3D Disto System Software

The 3D Disto includes a user interface software for computers with Windows operating systems.

#### Hardware requirements:

- Windows 7 and later. RT versions are not supported.
- Desktop devices or laptops with keyboard and mouse.
- Touchscreen devices and tablets.
- Screen resolution at least 680 × 1000 px
- 32 bit or 64 bit



Insert the Leica USB memory stick only into a USB port "Type A". For other port types, use an adapter. Ensure, that both the port and the adapter have "on-the-go" functionality (OTG).

## License Key

To enable the 3D Disto applications, the software needs a licence key. Refer to the following list for information about where to find the licence keys:

- On the delivery papers or receipt from your dealer.
- On the USB memory stick (key file).
- On the Leica myWorld website after registering your product.

## Activating Software Applications with the License Key

### Entering the License Key Manually

-  Connect the 3D Disto to your Windows device and start the 3D Disto software application.
1. On the main screen, press the Menu button. 
  2. Select **Device... » Software... » License... » Enter license keys.**
  3. Enter the license key and press **OK**.

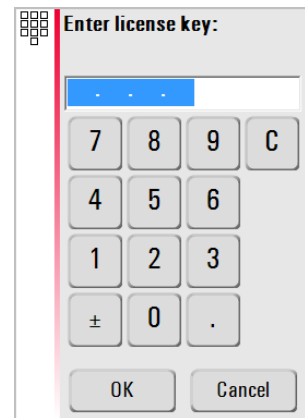

### Importing the License Key

1. Click on the 3D Disto Data icon on your desktop.
2. Copy the license key file into the folder "license".

## Customised Application Programs

Customised software, specific to user requirements, can be developed using the third-party software development environment. For further information, contact a Leica Geosystems representative.

## Software Update

1. Start your internet browser and go to the **myWorld** homepage. (<https://myworld.leica-geosystems.com>)
2. Register your product by entering the equipment number.
3. Choose the **myProducts** page, choose the latest software version and press the **Download** key.

## 2.5.2



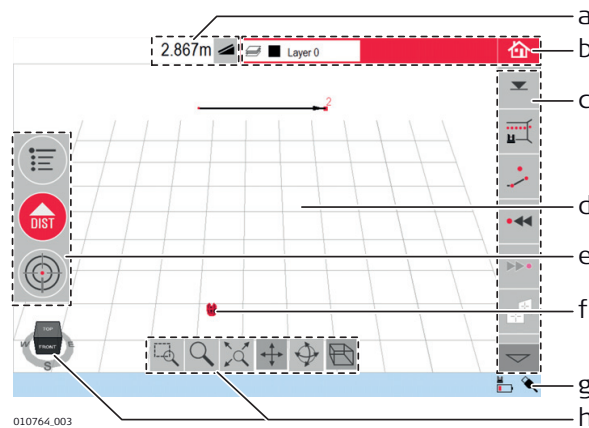

### User Interface

#### Home Screen

-  All shown screens are examples. It is possible that local software versions vary from the standard version.



- a Result window with result choice key
- b Title bar with layer window and Home key
- c Toolbar
- d Sketch area/Pointfinder
- e Main operation bar
- f 3D Disto position
- g Status bar
- h Navigation cube and tools

Element	Description
Title bar	Shows the running application and the active layer. Tapping on the layer window opens the layer control window.  save and close files or running applications.
Main operation bar	Contains the following buttons: <ul style="list-style-type: none"> <li>• Menu  Opens the menu to start applications or to define settings.</li> <li>• DIST button  Starts measurement or layout of points.</li> <li>• Pointfinder  Opens, closes and locks Pointfinder.</li> </ul> These keys are displayed during all applications.
Sketch area	Displays measured points, lines and areas and correct position of 3D Disto in relation to measured points - either in foot print or unfold mode/face mode.
Pointfinder	Shows 3D Disto live video stream used to target points and to take pictures.
Results window	Displays all results such as distances, heights, slopes, areas, angles together with the corresponding result choice key, for example  . Tapping on the results opens the calculator.
Toolbar	Contains application-specific tool keys. Refer to <a href="#">Toolbar of the Standard Application (Measure)</a> .
Status bar	Displays status of connections, batteries, running function mode and assistant support.
Navigation cube and tools	Changes perspective and scale of the sketch. Click on a face, a corner or an edge of the cube for pre-defined views. Use the navigation tools to adjust the view individually.

## Operating Principles for the Sketch View

### Selecting or Drawing Items

 Ensure, that the navigation tools are deactivated.

- To select a point or line in the sketch: Click with the mouse or tap with one finger.
- To draw a line: Select a point with mouse, stylus or finger, slide to the desired point and release.

### Adjusting the Sketch View with Navigation Tools

Use the navigation tools to adjust the sketch view individually.

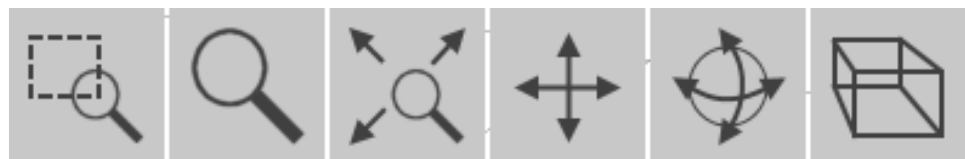

- Zoom by drawing a rectangular area
- Zoom
- Fit the whole model into the view
- Pan the sketch
- Rotate the sketch
- Change the perspective

To activate a navigation tool: Click or tap on it. The selected tool is highlighted and the cursor changes.

To deactivate a tool: Click or tap on it again.

### Adjusting the Sketch View with the Navigation Cube

- To adjust the sketch view: Also use the navigation cube.
- To adjust the view individually: Click and drag the cube.
- For pre-defined views: Click on a face, a corner or an edge of the cube .

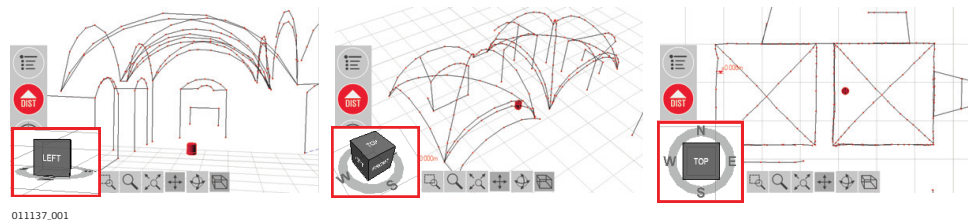

### Gestures for Touch-Screen

If your device has a touch screen, you can use two-finger gestures for quickly adjusting the sketch view without using the navigation tools:

Swipe:

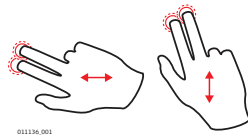

Zoom in:

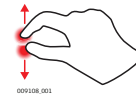



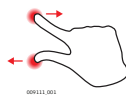

Rotate:

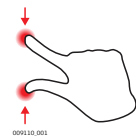









Zoom out:









### Toolbar of the Standard Application (Measure)

Key	Description
	Enter and measure a reference height.
	Start a line or surface scan.
	Disable line drawing.
	Go one point backward.

Key	Description
	Go one point forward.
	Display all photos in the sketch.
	Display list of CAD tools.
	Confirm the current operation.
	
	Start area or volume mode.
	Undo or redo last command.
	
	Clear functions.

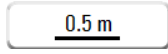













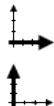



### Status Bar





Icon	Description
	Indicates remaining battery capacity for the 3D Disto.
	Indicates 3D Disto is connected to power supply.
	Indicates USB connection between Windows device and 3D Disto.
	Indicates WLAN connection is working.
	Scale of sketch area and key to change zoom level.
	Indicates zoom level/magnification of Pointfinder.
	Indicates tilt sensor is turned off.

### Icons in the Result Window

Icon	Description
	Horizontal Distance

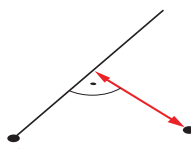

Icon	Description
	Tie distance
	Height, height difference
	Left angle
	Right angle
	Coordinates: X, Y
	Tilt
	Horizontal/tilted area
	Horizontal/tilted area perimeter
	Volume height
	Volume
	Circle size
	Circumference
	Diameter
	Length of arc
	Radius of arc
	Scan area
	Scan perimeter
	Scan volume

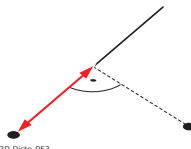

Icon	Description
	Distance between point and plane.
	<p>Perpendicular distance of a point to the reference line.</p>  <p>3D Disto_052</p>
	<p>Distance from the reference line base point to the foot of the perpendicular.</p>  <p>3D Disto_053</p>

## 3 Instrument Setup

### 3.1 Setting Up 3D Disto

#### Setup Step-by-Step

The following description assumes setup on a tripod. You can also place the 3D Disto on flat surfaces such as floor or boards.

Step	Description
	It is always recommended to shield the instrument from direct sunlight and avoid uneven temperatures around the instrument.
1.	Set up the tripod in a suitable place where the points to be measured can be targeted well and extend the tripod legs to a comfortable working height.
2.	Place the 3D Disto onto the tripod head. Tighten the central tripod fixing screw.
3.	Centre the circular bubble on the 3D Disto by adjusting the tripod legs.
4.	Press  to turn on the instrument. <i>3D Disto starts self-levelling: the tilt is checked by a tilt sensor and the instrument levels itself if the tilt is &lt;math&gt; &lt; 3^\circ &lt;/math&gt;.</i>
	Do not move the 3D Disto while self-levelling procedure is running.

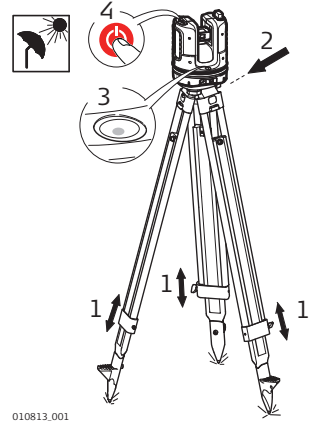

### 3.2 Connecting the 3D Disto to a Windows Device

#### Connect 3D Disto to a Windows Device Step-by-Step

#### Starting the Software

Step	Description
1.	To start the software, click the 3D Disto icon on your desktop.

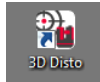

When starting the software for the first time, the following screen is displayed:

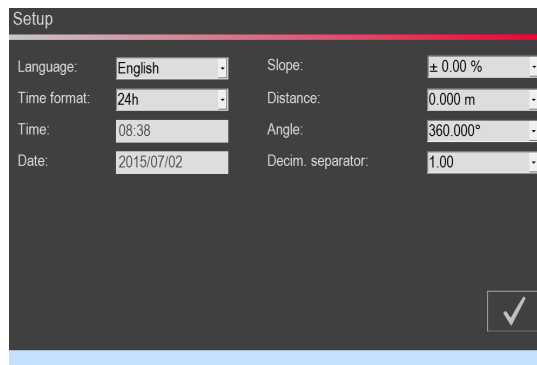

If necessary change the settings.

Press  to continue.

Step	Description
------	-------------

The following screen opens:

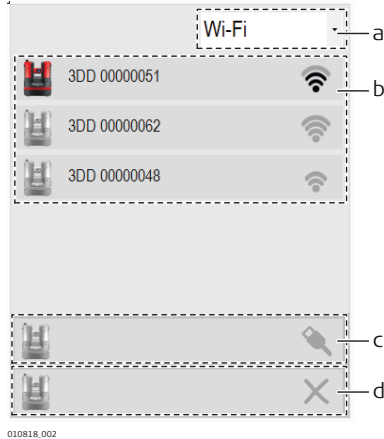

- a Select the WLAN interface.<sup>1)</sup>
- b List of available WLAN devices and their respective signal intensity. Select a device to connect.
- c If you prefer a cable connection, plug in the USB cable and click here.
- d In order to continue without connection, click here.

### 3.3

### Assistant

#### Assistant and supporting icons

There is an assistant available that will guide you through all measurement tasks with illustrated pop-ups.

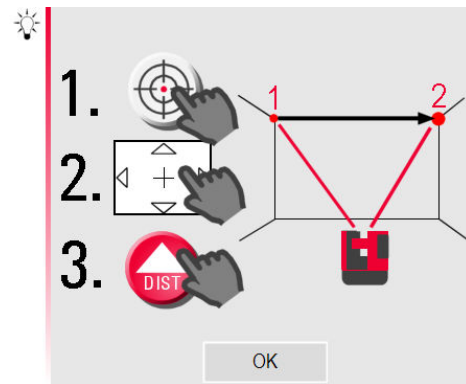

If not needed, it can be deactivated in **Menu » Settings » Assistant**. If assistant is deactivated there are still supporting icons in the status bar, showing which application is running and what user action is required.

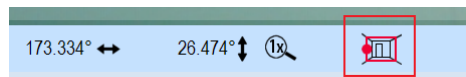

<sup>1)</sup> 3D Disto devices with serial number 175... and 177... need an external WLAN USB stick.

## 3.4

## Tilt Sensor

### Tilt Sensor

A built-in tilt sensor ensures that measurements relate to true horizon or true plumb line, defined by gravity. The tilt is checked by a tilt sensor and the instrument levels itself if the tilt is  $< 3^\circ$ .



If 3D Disto cannot be levelled the  in the status bar is blinking. Level the 3D Disto or cancel the levelling procedure.



#### For advanced users only:

If the tilt sensor is OFF the system does not compensate the tilt of the 3D Disto. All results that refer to a physically horizontal plane, for example tilt, height differences, horizontal distances, angles, areas, or volumes, now refer to the tilted horizon of the laser unit. Only the tie distance between two measured points is independent of the tilt sensor's setting. It can be useful to disable the tilt sensor in case of vibrations, for example on construction sites or in unstable or moving environments such as on boats. Almost all measurements can still be completed and exported data can be "levelled" afterwards by CAD software.

## 3.5

## Device Configuration and Menu Settings

### Device Configuration

All settings on the setup screen can also be changed through the menu: Choose **Menu » Device**.

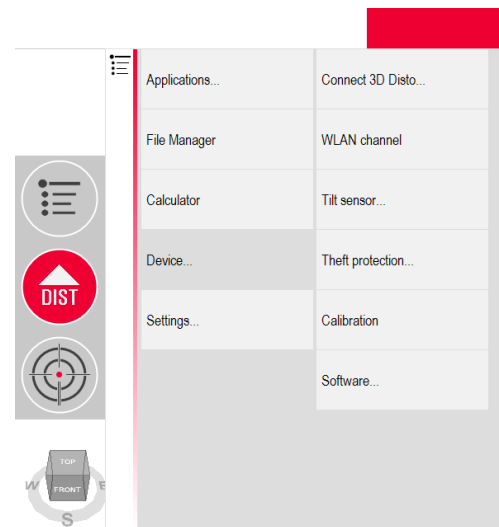

- **Connect 3D Disto** to connect by WLAN, USB cable, or disconnect.
- **WLAN channel** to switch between different channels if connection does not work.
- **Tilt sensor** to activate/deactivate the tilt sensor. Choose **ON** when working in harsh construction environment with many shocks and vibrations, apart from that choose **ON (sensitive)**.
- **Theft protection** to protect instrument with security PIN.
- **Calibration** to check and adjust. Refer to [8 Check & Adjust](#) for more information.
- **Software** to update software, to check software version or to enter/activate the software license key.

## Settings

Press **Menu » Settings**, the following options appear:

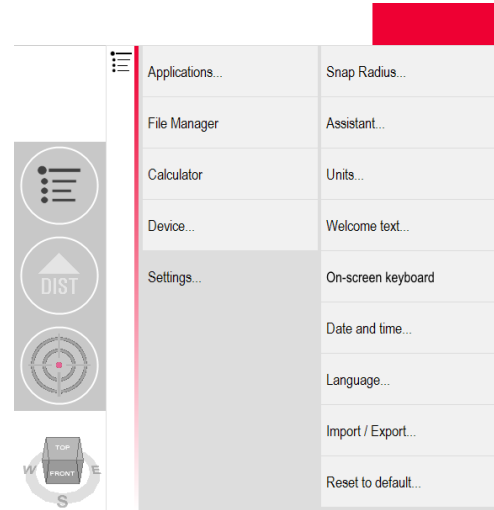

- **Snap Radius** to define the area around a point/line. This setting offers a list of points that are very close to each other to simplify their selection.
- **Assistant** to activate/deactivate the assistant.
- **Units** to change the unit settings.
- **Welcome text** to enter for example company name.
- **On-screen keyboard** to define the display mode for the on-screen keyboard on your touch-screen devices. Automatic: The on-screen keyboard is displayed automatically as soon as you are prompted to enter characters.
- **Date and time** to change date and time settings.
- **Language** to choose your preferred software language.
- **Import/Export** settings to change format, coordinates and list separator.
- The instrument has a **Reset** function. If you select the menu function **Reset to default** and confirm, the device returns to the factory settings. All measurement data is kept.

## 3.6

### Data Management

### 3.6.1

#### File Manager





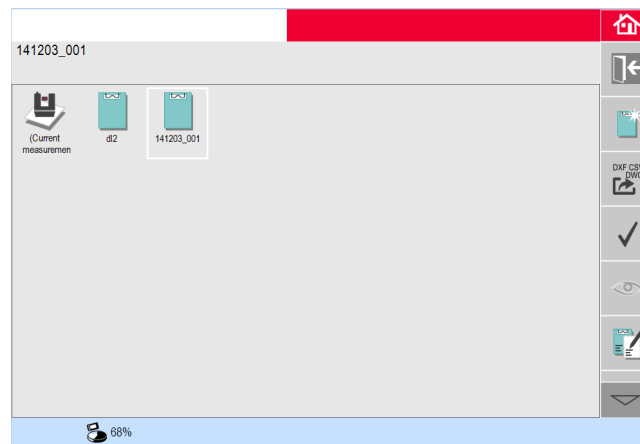

#### File Manager

The File Manager handles the entire data administration measurement files, photos Secure Points and data transfer.









To access the File Manager, press the **Menu** key  and select **File Manager**.



**Description of keys:**

Icon	Description
	Project folder
	Folder with photos
	Folder with Secure Points
	Temporary file
	Measure file
	Projector file

**Toolbar Keys within File Manager**

Key	Function
	Close folder/File Manager
	Go to higher folder level or close File Manager
	Create a folder and enter a folder name
	Open a selected file or folder
	View the selected element.
 DXF CSV DWG	Data export. Refer to <a href="#">3.6.2 Export and Import of Data</a> .
	Rename file or folder
	Clear a selected file or folder.

**Photo and Secure Points Administration**



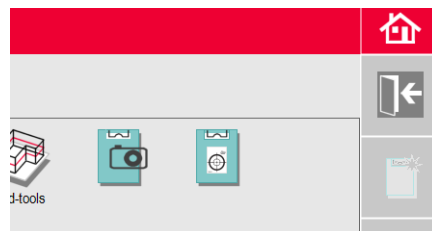

Photos and Secure Points are stored in separate folders.





### 3.6.2

## Export and Import of Data

### Data Export Step-by-Step

Step	Description
	Export applies the distance unit setting to exported coordinates. This setting can be modified any time before an export is executed.
	The import/export settings in the menu allow to set the coordinates of the first measured point of each application. This setting must be done before the first point in a new project (e. g. a new scan) is measured; the setting does not apply retrospectively.
1.	Open File Manager, choose a folder or file and press  .
	A key press on  generates a package of export files: <ul style="list-style-type: none"><li>• DXF and DWG files: 2D, 3D</li><li>• CSV file: editable, common tabular data format</li><li>• TXT file: all results in editable ASCII format. Same content like CSV file</li><li>• JPG files of photos and Secure Points.</li></ul>
2.	Export data is transferred to the <b>Export</b> folder in the directory My Documents\Leica Geosystems\3D Disto on your PC.

### Data Import Step-by-Step

Step	Description
	It is possible to import DXF files or table formats for some applications.
	Data should be prepared on the PC before importing. Only points are imported, no lines. Remove irrelevant data such as frames, logos, coordinates, or orientation arrows in the DXF files before importing them.
1.	To access the Import folder, click on the <b>3D Disto Data</b> icon on your desktop. 
2.	Copy the CSV or DXF files to the Import folder.
3.	Refer to <a href="#">6.3 Projector</a> for more information.

## 3.7

## Calculator

### Using calculator

- Tap on the result in the result window to start the calculator.
- Another option is to press **Menu » Calculator**.

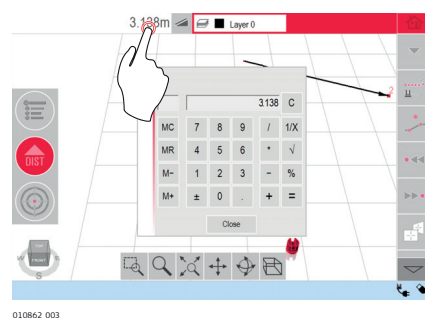



## Memory Function

The memory function allows you to add or subtract results, e.g. areas or volumes.

- Click **MC** to clear memory.
- Click **MR** to retrieve a value stored in memory.
- Click **M-** to subtract the displayed value from the value in memory.
- Click **M+** to add the displayed value to the value in memory.



To save a certain value to the memory: Click **MC** to clear memory, enter value and press **M+**. To save the value as negative value, press **M-**.

---

## Horizontal Angle

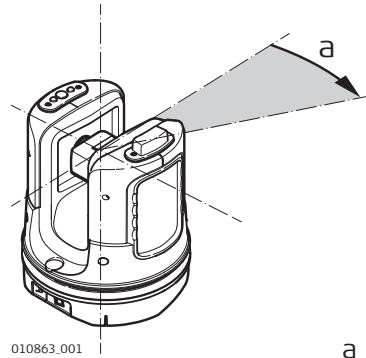

010863.001

a Horizontal angle: [°] or [gon]

---

## Vertical Angle

**Setting: Horizon = 0**

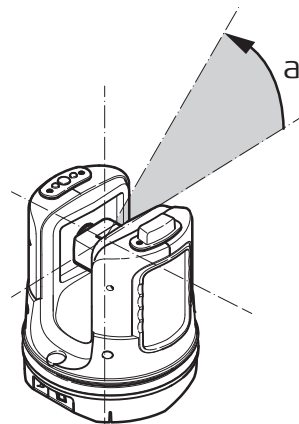

010864.001

a Vertical angle: [°], [gon], [1:n] or [%]

**Setting: Horizon = 90°/100 gon**

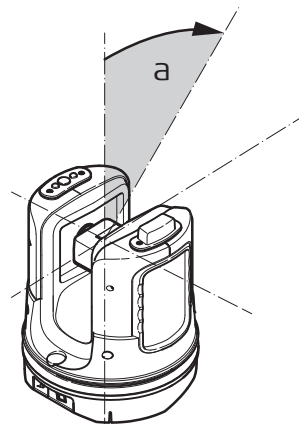

010865.001

a Vertical angle: [°] or [gon]

---

## Distances

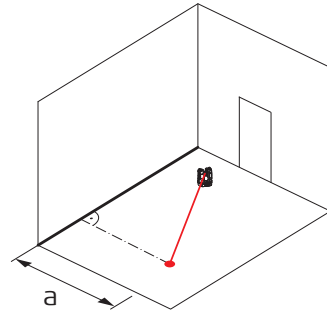

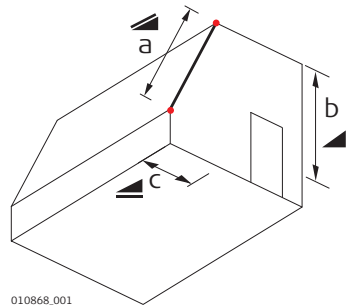

010867\_001

a Perpendicular distance



010868\_001

a Tie distance   
 b Vertical distance  = height difference  
 c Horizontal distance 

## Areas

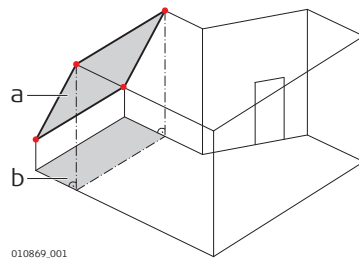

010869\_001

a Tilted area, as measured  
 b Horizontal area, calculated by 3D Disto

## References

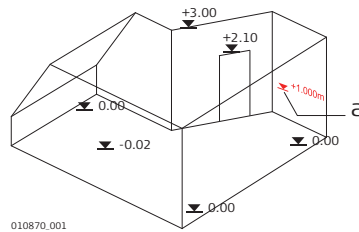

010870\_001

a **Reference height:** A level that all heights refer to.

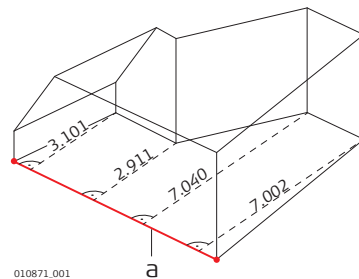

010871\_001

a **Reference axis/line:** A line that all dimensions refer to.

## Tilt Sensor

The tilt sensor guarantees correct results even if the 3D Disto is not set up horizontally.

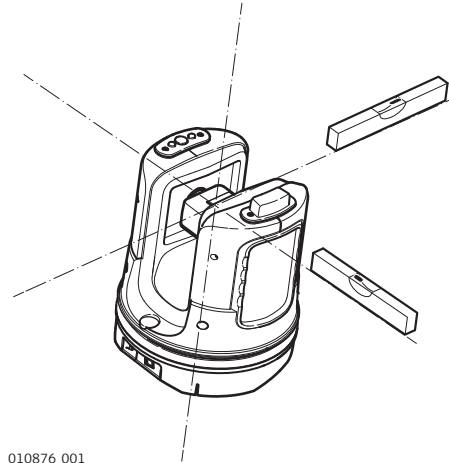

Tilt sensor off = disabled  
All measurement results relate to the **tilted axis and horizon** of the 3D Disto.

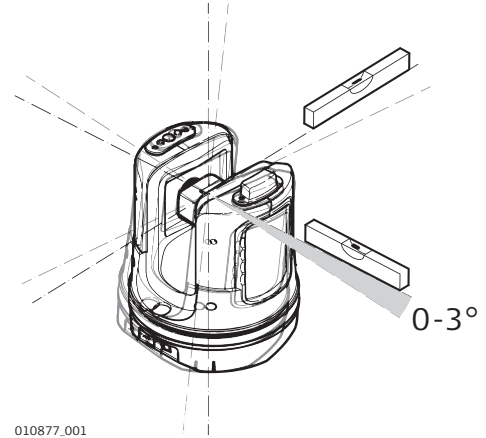

Tilt sensor on = enabled  
All measurement results relate to the **horizontal axis and horizon** if the 3D Disto is set up between 0° and 3°.

## Secure Points

Secure Points **link measurements to a coordinate system**. These reference points allow changing the 3D Disto location or continuing measurements at a later time, so that all measurements fit together perfectly.

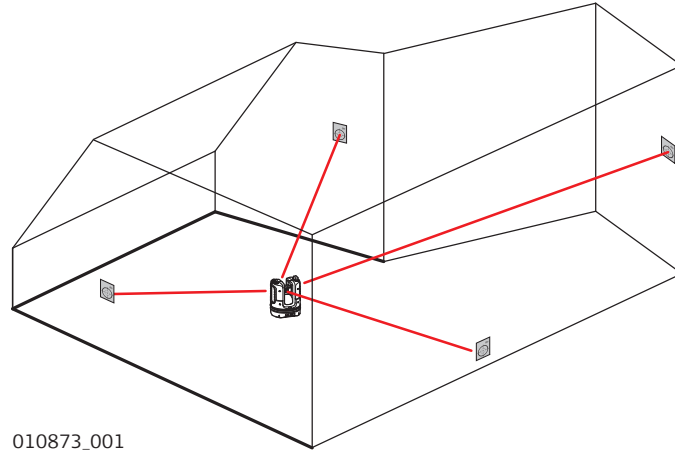

Refer to [6.4 Location](#) for more information.

## Layout or Projection

Design data in DXF and common table formats can be imported and used to lay out the corresponding points or grids.

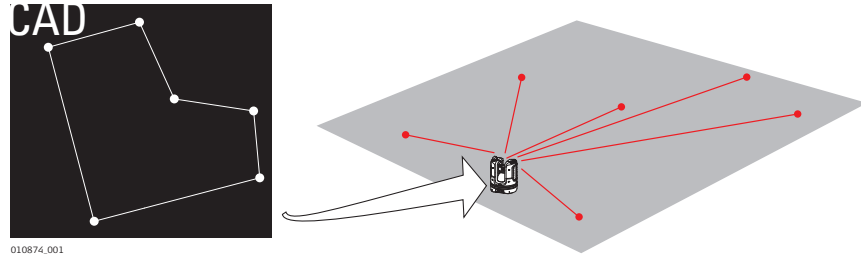

---

## Laser Distance Meter

The laser distance meter (LDM) determines distances using a visible red laser beam.

---

## Calibration

Calibration is a workflow to check and adjust the accuracy of the instrument. Refer to [8 Check & Adjust](#) for more information.

---

## Ruler for offset points

The ruler for offset points is an accessory to measure inaccessible or hidden points.

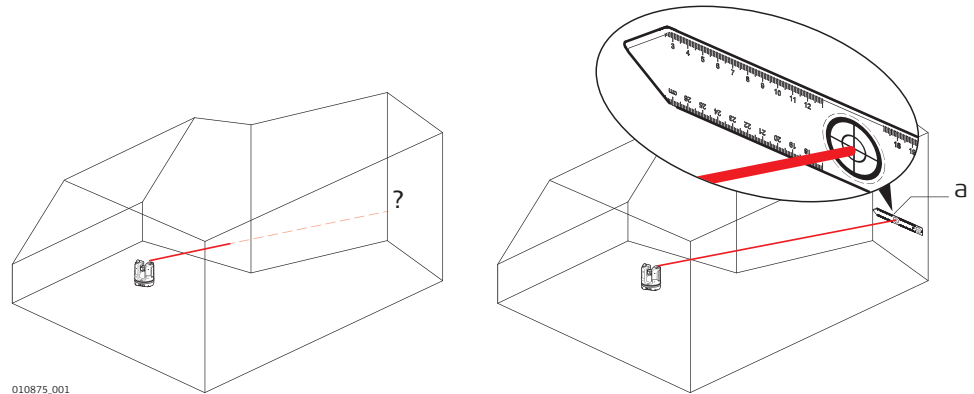

a Ruler for offset points

## 5 Operation

### 5.1 Measurements

#### Description

The 3D Disto is a combination of a precise laser distance meter (LDM) and angle encoders. Measurements are used to establish the relation between different targets, such as horizontal distances, tie distances, height differences to determine room dimensions, angles from wall to wall, areas, volumes, plumb points, or other features.

### 5.2 Using Layers

#### Description

The measurements can be organized on different layers. The coordinate system remains the same from one layer to another, so points and lines on separate layers remain aligned.

The name and colour of the current layer is shown in the title bar.

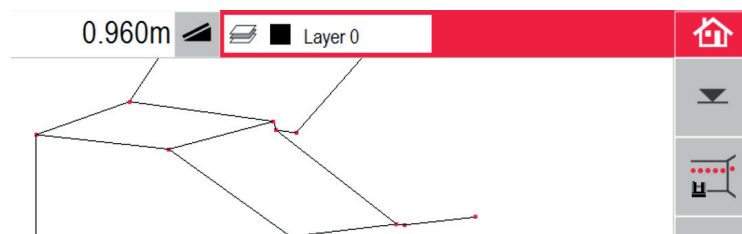

#### Layer control panel

A short press on the layer window in the title bar will open the layer control panel.

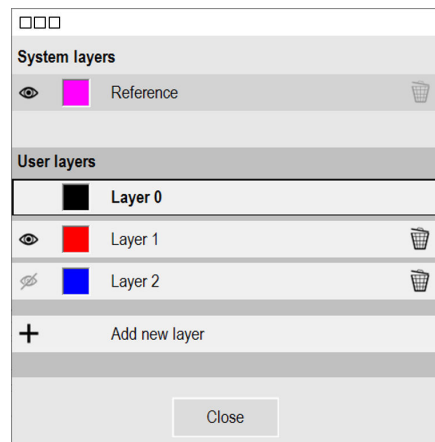

#### System layer

Reference and secure points are automatically added to this layer. Its colour can be changed, it can be hidden and displayed again, but it can't be deleted or renamed.

## User layer

Default user layer is "Layer 0".

- You can add up to 20 additional user layers within one measurement file. The current (active) layer is highlighted.
- Short press on the layers name makes this one the current layer.
- Long press or double-click on the layers name will open the keypad to re-name the layer.



Short press on this icon will hide this layer.



Short press on this icon will display the points and lines within this layer.



Add a new layer.



Delete this layer.



Layer can't be deleted because either there is no second user layer, or there are already points or lines within this layer.



Short press on the colour box will open the colour control panel.

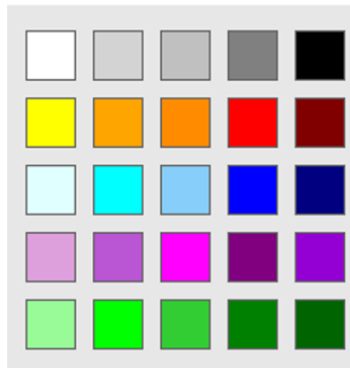

Press on the desired colour box to change.

## 5.3

### Pointfinder

#### Description

The 3D Disto has an integrated camera. It is accessible by  and it shows the camera image directly on the 3D Disto display. The crosshairs in the Pointfinder image allow precise targeting and measuring even if the laser beam is not visible, for example over long distances or because of bright backlight conditions.

## Example of a Pointfinder screen:

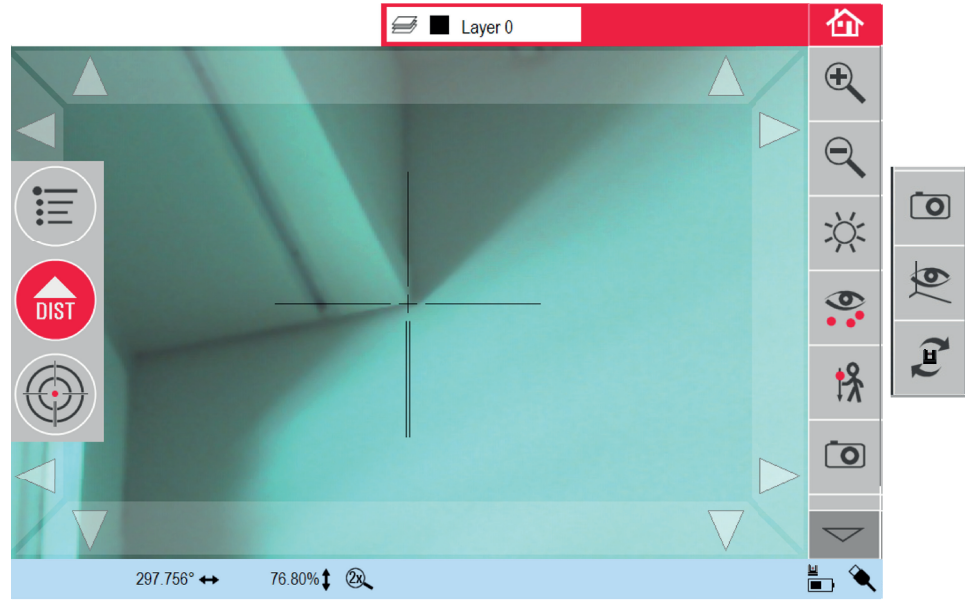

## Using Pointfinder

### Pointfinder Key

To start the Pointfinder, press .

A second key press activates the lock mode, a third one unlock and closes

Pointfinder. A lock symbol on a key indicates the lock mode. .

Targeting: There are different options to target a measurement point:

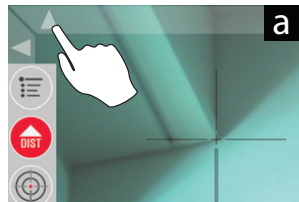

a) Press the arrow keys on the screen for targeting, hold for fast 3D Disto turns and short taps for single step turns.

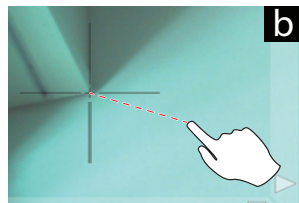

b) **Tap & Measure Targeting:** tap on a position on the screen. Laser point turns to this point automatically.

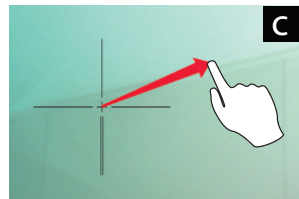









c) **Joystick Targeting:** is activated by long tap on the centre of the crosshairs. A red dot appears in the centre. Slide stylus on the screen to turn 3D Disto in this direction in real-time until red arrow is released. The longer the red arrow is, the faster the 3D Disto turns.

011126.001



## Toolbar description

Key	Function
	Press to zoom in or out.
	
	Press to adjust the brightness of the camera.
	Press to display/hide all measured points.
	<p>Press to measure hidden points. Select an offset tool in the pop-up:</p>  <ul style="list-style-type: none"> <li>• Vertical offset: Measure one point on any vertical target.</li> <li>• Individual offset: Measure two points on a pole or other hardware.</li> <li>• Offset ruler: Measure two points on the 3D Disto offset point ruler.</li> </ul> <p>An assistant leads through the workflow.</p>
	Press to take pictures for documentation purposes.
	Press in dark conditions to change Pointfinder picture to edge mode. Edges and corners will be highlighted in black.
	<p>Press to choose between different turn commands:</p> <ul style="list-style-type: none"> <li>• Turn 90° right</li> <li>• Turn 90° left</li> <li>• Turn ?°: Enter the horizontal angle by which the 3D Disto should turn.</li> <li>• Horizon: 3D Disto goes to 0% slope in horizontal position.</li> <li>• Plumb up: This option can be used to plumb up a point by setting up the 3D Disto exactly over it. Use the 90° markings on the 3D Disto socket for centring.</li> </ul>

## 5.4

## Measurement Workflow

### Measurements step-by-step

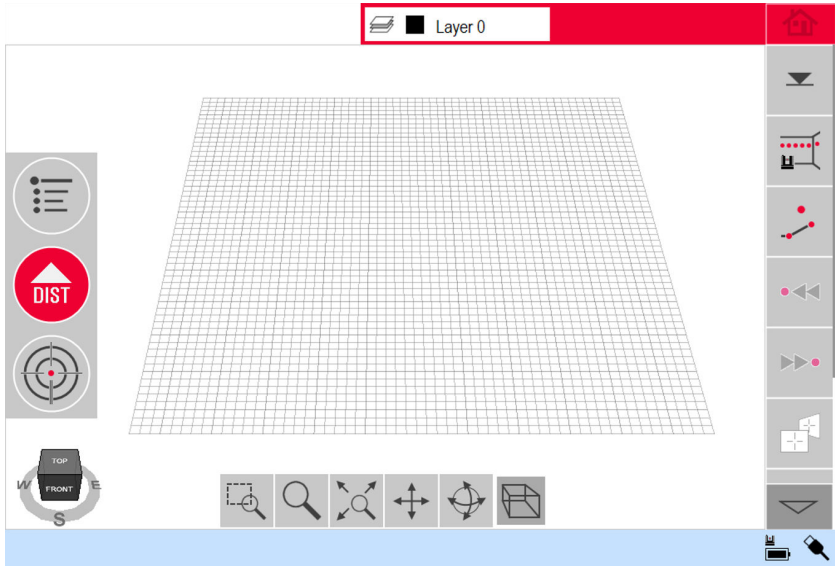
Step	Description
1.	 The screenshot shows a software interface for a measurement tool. At the top, there is a red header bar with a layer selection menu showing 'Layer 0'. Below this is a large grid representing a measurement plane. On the left side, there is a vertical toolbar with icons for a list, a red 'DIST' button, a target icon, and a 3D view selector showing 'TOP', 'FRONT', and 'S' views. At the bottom, there is a horizontal toolbar with icons for zooming, panning, and other navigation functions. On the right side, there is a vertical toolbar with icons for various measurement and display functions.

To target the first point, for example a corner, press  and use the arrow keys or another method as described in [5.3 Pointfinder](#), to move the laser point to the desired position.



While targeting, ensure the laser beam is not split along corners or edges.

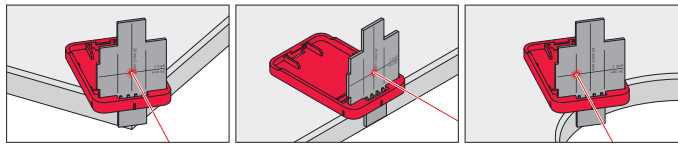



2.

Press  to measure.

Step	Description
------	-------------

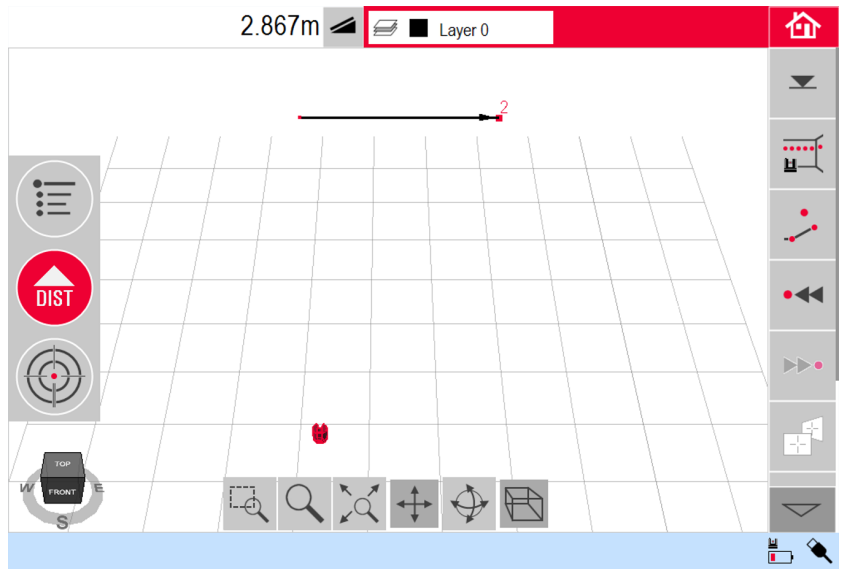
3. Target the second point as described in the previous steps.  
*A line is displayed from the first to the second measured point.*



4. Proceed as described for measuring further points or use  to close/finish the polygon.

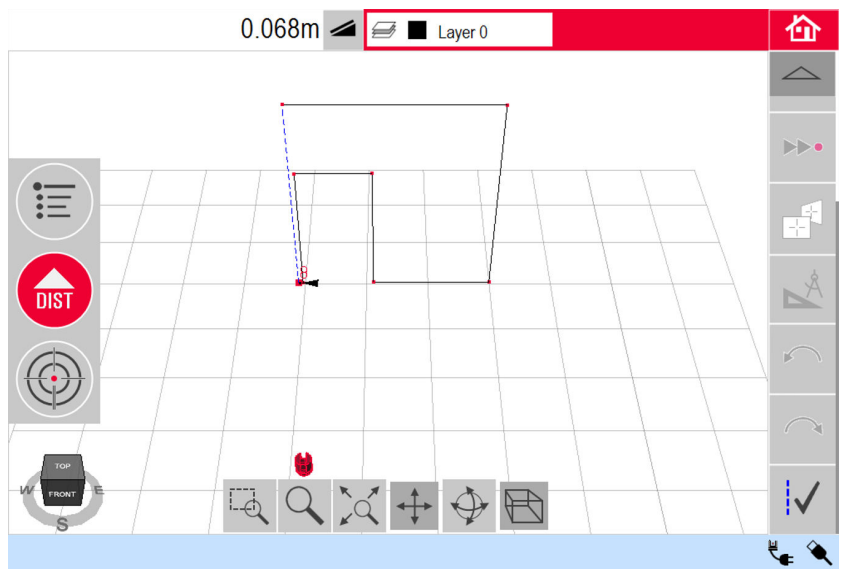

Step	Description
------	-------------



In special situations the proposed line is not available. Polygons can also be closed and results created by drawing a line with the stylus between the two points to be connected.

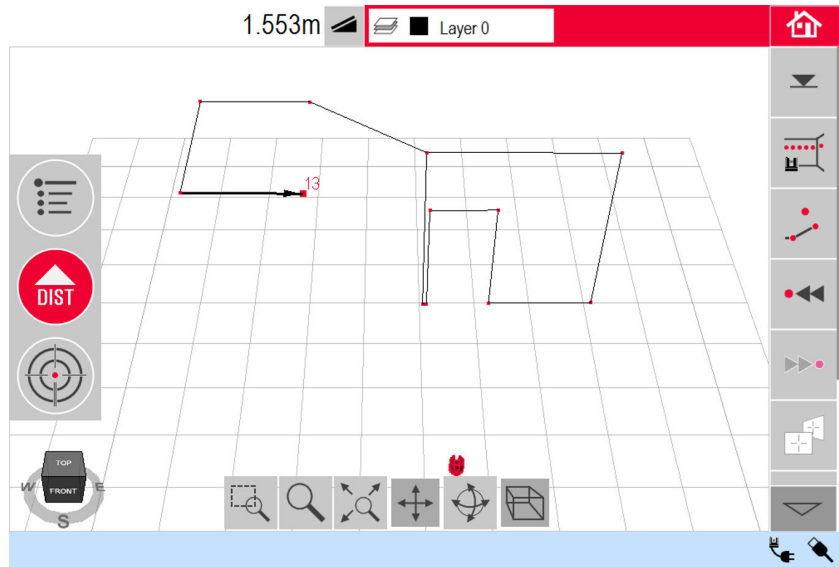

To change the view to a suitable perspective, use the navigation tools or click on the navigation cube.

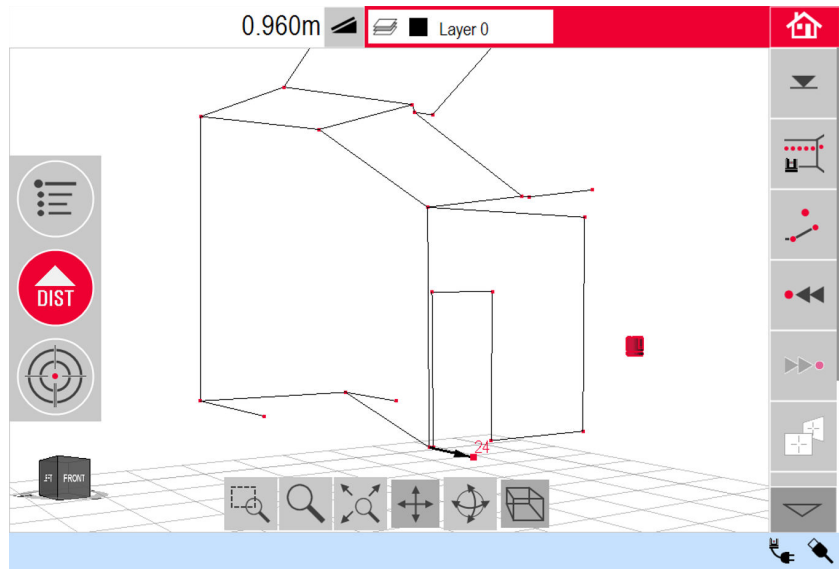







5. Press  to choose between save, save as, clear screen, close measurements without saving.

## Areas & Volume Calculations

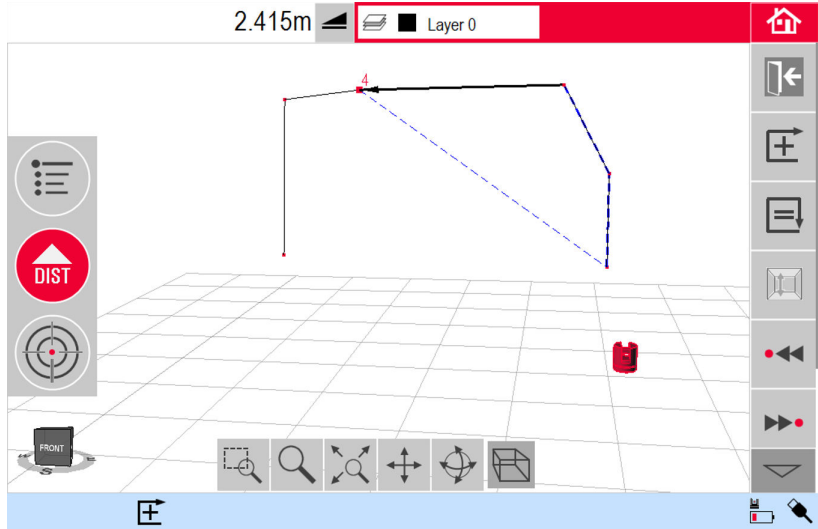
The 3D Disto can also help determine areas and volumes. Both can be determined during or after measuring.

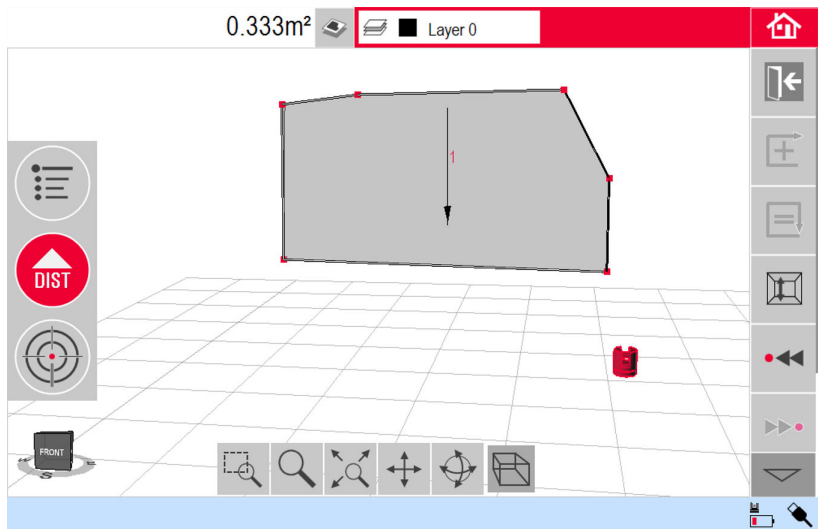
Step	Description
------	-------------

1. Press .

Step	Description
2.	Select line to be added to area and press  .
	
3.	Proceed that way for all lines and press  .
	
4.	<i>Pop-up appears to choose between the different options to define the height:</i>
<ul style="list-style-type: none"> <li>• <b>Enter height:</b> Enter a desired value and press OK.</li> <li>• <b>Measure height:</b> Pointfinder opens, target and measure a point on floor with , followed by point on ceiling. You can measure the points anywhere on the floor or ceiling area. The height appears in the results window.</li> <li>• <b>Close list:</b> The result is an area.</li> </ul>	
5.	To change the height or to calculate the volume with a selected area press  and proceed as described in the previous steps.
6.	Quit application by pressing  .

## 6 Software Applications

### 6.1 Overview

#### Description

There are a variety of software application programs available addressing a wide spectrum of construction tasks and facilitating daily work.

- **Measure:**  
Provides practical features to measure room dimension, walls, windows, stairs and other details with reference height, manually or automatically.
- **Projector:**  
Enables layout of grids and other design data on floors, ceiling, or walls.
- **Location:**  
Routine to easily and correctly check and relocate the position of the 3D Disto.
- **Tool Kit:**  
Smart measuring and set-out tools.

### 6.2 Measure

#### Description



This application program measures room dimensions, including details. For these measurements several additional features are available:

- Reference Height
- Single point measurement
- Scan tool for automated scans
- CAD tools

#### 6.2.1 Reference Height

##### Define a Reference Height Step-by-Step

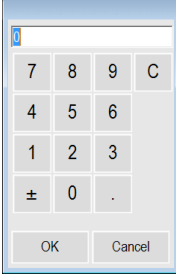
Within the measure application, you can define a known height as reference height. All further measured heights will refer to this reference height.

Step	Description
1.	Press  .
	Pop-up prompts to enter and measure reference height. Enter the value and press <b>OK</b> .
2.	
3.	<i>Pointfinder opens.</i> Target the reference height and press  .
4.	<i>Reference height is displayed in the sketch area.</i>

## 6.2.2

## Scan Tool for Automated Scans





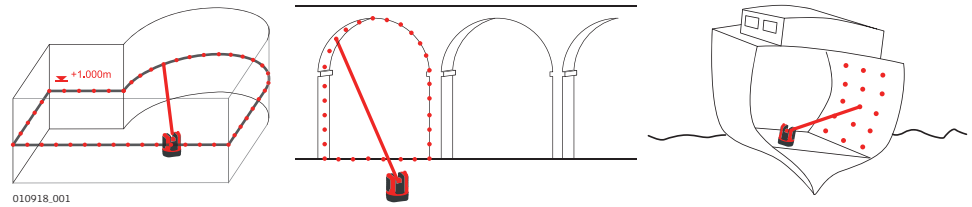

### Description

This tool executes automated horizontal, vertical and slope profile measurements and surface scans.

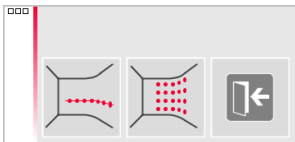
Ideal for measuring rooms with non-square corners or curved walls, inaccessible points, slopes or areas.

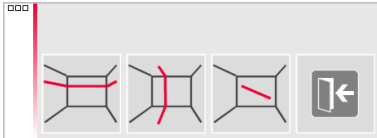

### Line Scan, step-by-step

Step	Description
1.	Press  to start scan.
2.	Pop-up offers line scans and surface scans.  Press  to select line scans.
3.	Pop-up prompts scan types.  <ul style="list-style-type: none"> <li>• Horizontal</li> <li>• Vertical</li> <li>• Slope</li> </ul>
4.	Pointfinder opens to target and measure start point. Target and press  .
	For vertical line scan: Pop-up prompts to choose scan orientation: <ul style="list-style-type: none"> <li>• Perpendicular to wall</li> <li>• Free: An assistant leads through the workflow.</li> </ul> 
5.	Pop-up prompts to define scan direction.

Step	Description
------	-------------

**Horizontal Line Scan:**

- Left (360°)
- Point-to point
- Right (360°)



**Vertical Line Scan:**

- Up (360°)
- Point-to point
- Down (360°)

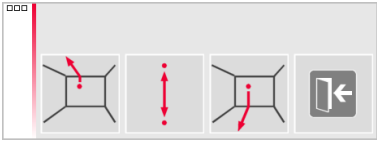



**Slope Scan:**

Pointfinder opens.



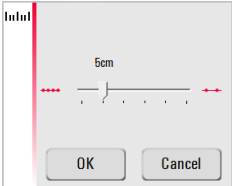

Target scan end and press .

- 
6. *Pop-up window prompts to define spacing of the measurement.*  
Choose an interval and press **OK** or go to the rightmost position to enter individual intervals.



- 
-  For best scan results do not choose small intervals at long distances.

- 
7. Press **OK**.  
Scan starts.

- 
-  *Toolbar changes.*
- Press  to start the camera. Press again to unlock.
- Press  to change scan spacing, skip the rest of the scan, continue scan, or cancel scan.
- Press  to skip a scan point that you do not need or that causes problems.

- 
8. If scan is finished pop-up prompts **Ready. Edit Scan? Yes/No.**
-



Step	Description
------	-------------

9. If **Yes**: New Toolbar appears, e.g. to measure missing points with DIST or delete unneeded points with Trash key Symbol.

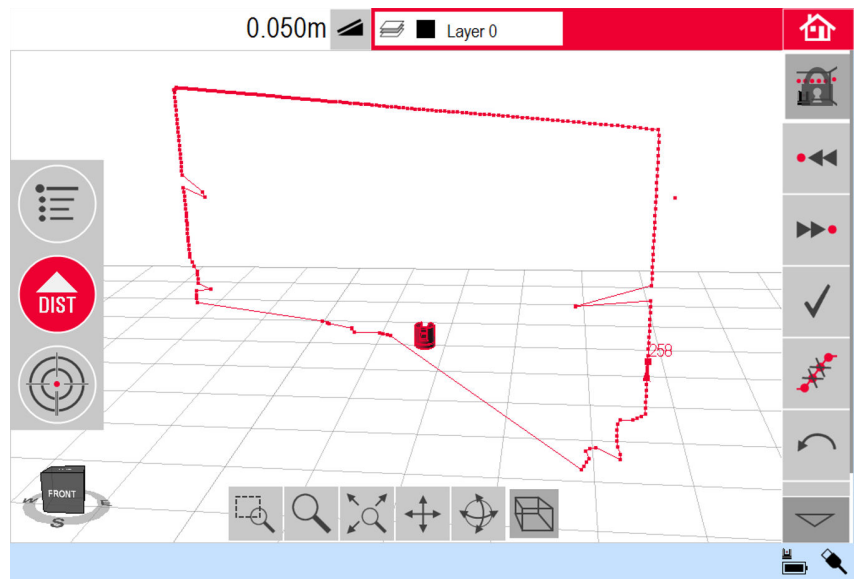

Press or to select points.

Press to start a scan simplification that automatically clears aligned points.

Press to finish the scan.

10. Press to save and close measurement file.

### Surface scan, step-by-step

Step	Description
------	-------------

1. Press to start scan.

2. *Pop-up offers line scans and surface scans.*

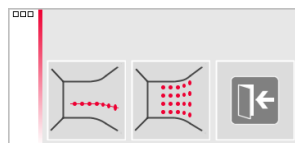





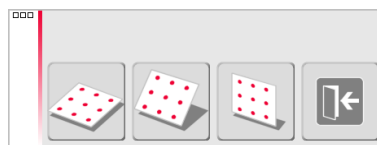



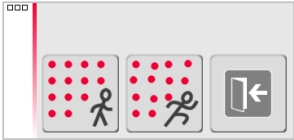

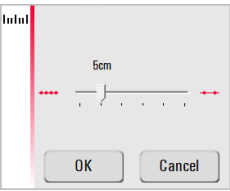
Press for surface scan.

3. *Pop-up offers three scan options: horizontal, slope and vertical:*  
Select your preference according to the surface you want to scan.



Use vertical or horizontal scan to measure on walls, floor and ceiling.

Step	Description
	Slope scan is ideal to check the flatness of any surface, independent of its inclination.
4.	Select "precise" or "speedy" option. "Precise" finds the exact position of each scan point. "Speedy" prioritises short measuring time and robustness. Measurement accuracy is equal.
	
5.	<i>The Pointfinder opens for measurements to define the scan area:</i> Define the <b>Scan Area</b> : <ul style="list-style-type: none"> <li>horizontal &amp; vertical: measure 2 edges (3 points). The area is completed automatically</li> <li>slope scan: measure the borders of the scan and press  to continue.</li> </ul>
6.	<i>Pop-up window prompts to define spacing of the measurement.</i> Choose an interval and press <b>OK</b> or go to the rightmost position to enter individual intervals.
	
	For best scan results do not choose small intervals at long distances.
7.	Press <b>OK</b> . <i>Scan starts.</i> <i>The deviation of each scanned point to the reference plane is displayed in the result window.</i>  <i>For geometric reasons, scan volume computation is an approximation.</i> 
	<i>Toolbar changes.</i> Press  to start the camera. Press again to unlock. Press  to change scan spacing, skip the rest of the scan, continue scan, or cancel scan. Press  to skip a scan point that you do not need or that causes problems.
8.	Press  to save and close measurement file.

### 6.2.3

### CAD Tools

#### Description

CAD tools is a set of drawing functions.

Click the button in the toolbar to display the CAD tools. 

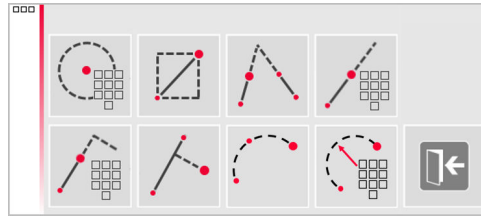

The following tools are available:

- Circle
- Rectangle
- Line Intersection
- Line Extension
- Point Shift
- Perpendicular Intersection
- Arc with 3 points
- Arc with 2 points and radius

## Circle Tool

The circle tool's purpose is mainly to draw a circle on points like sockets or holes.

Step	Description
1.	Target and measure a point and activate circle function by a long tap on the point in the sketch area.
2.	Select <b>Circle</b> .



3. *Pop-up opens.*

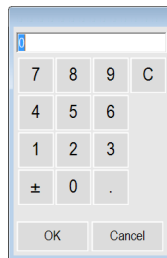

Enter the value and press **OK**.

Step	Description
------	-------------

- Circle is drawn around the chosen point. The results window contains radius, circumference and size of the circle.

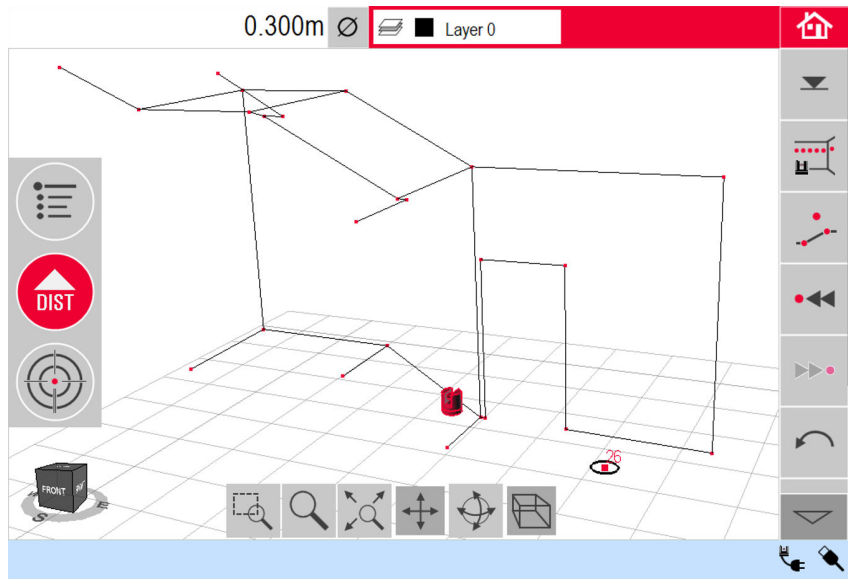

To clear the circle, enter 0 as value for the diameter or press .

## Rectangle Tool

Step	Description
------	-------------

- Measure first and second point of the diagonal of a rectangle, for example a window, and activate the CAD tool by long tap on the line.

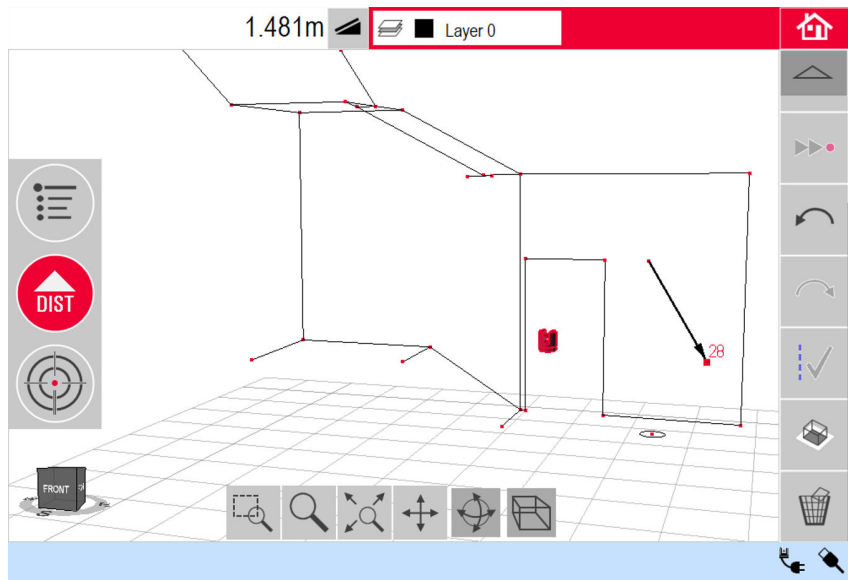

- The CAD tools menu opens. Select **Rectangle**.



Step	Description
------	-------------

3. *Diagonal changes to a levelled rectangle.*

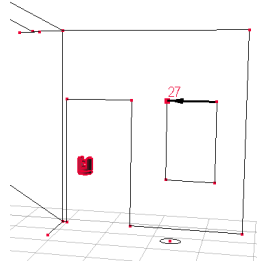

### Line Intersection Tool

The **Line Intersection tool** finds the intersection point between two lines.

☞ Intersection location is computed two-dimensionally in the X-Y plane. Intersection point height is computed by extrapolation of the first line.

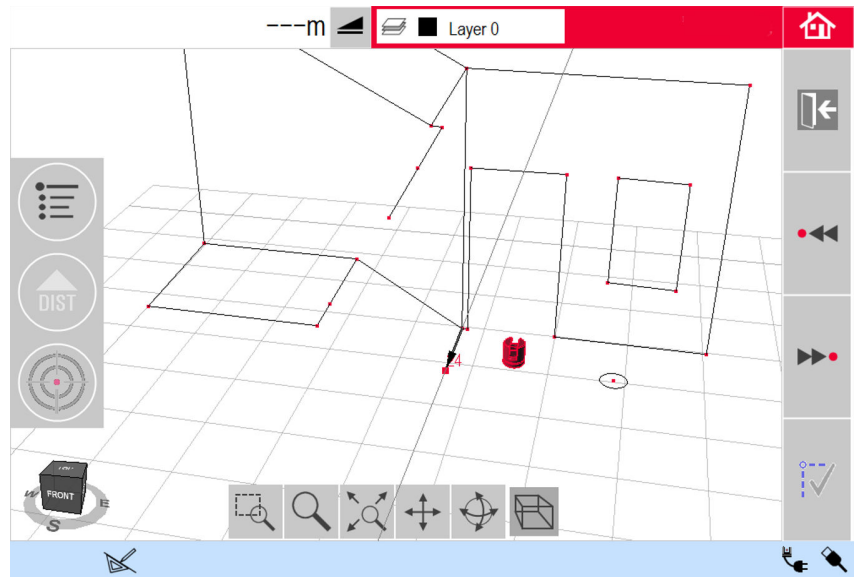

Step	Description
------	-------------

1. Target and measure two points or select an existing line.



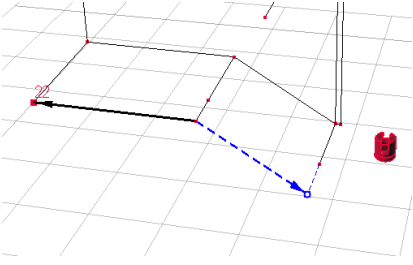

2. Activate CAD tools by a long tap on the line in the sketch area. Select **Line Intersection**.

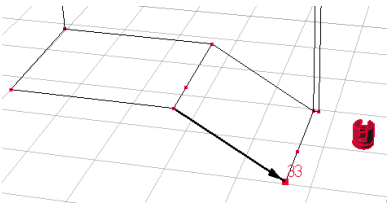

Step	Description
3.	<p>The assistant prompts for selecting a second line.            Select a second line.            The intersection point is proposed once a line is chosen:</p> 
4.	<p>After  was pressed, the intersection point is generated and the connecting lines to the existing points are added.</p>
5.	

**Line Extension Tool**

The **Line Extension tool** expands a line by a manually entered distance value.

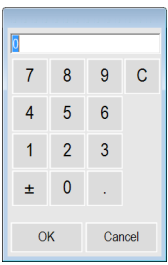
Step	Description
	Line Extension end-point is computed as the 3-dimensional extrapolation of the selected line.
1.	Target and measure two points or select an existing line.
2.	Activate the CAD tools by a long tap on the line in the sketch are. Select <b>Line Extension</b> .
	
3.	<p>The pop-up prompts for the extension length.            Enter a value and press <b>Ok</b>.</p> 

Step	Description
------	-------------

4. The Line Extension end-point is proposed:

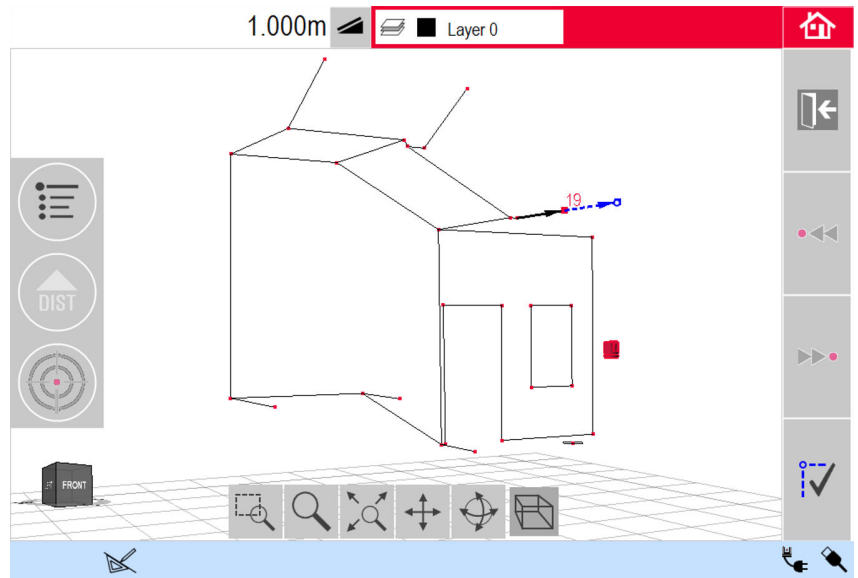

5. After  was pressed, the new point is generated and the connecting line to the previous point is added.

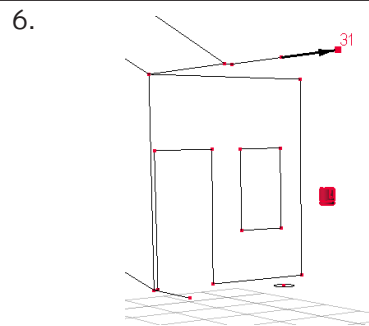

## Point Shift Tool

The **Point Shift tool** creates a new point by providing lateral movement value along an existing line, offset and offset angle.

Step	Description
------	-------------



Point-shift location is computed two-dimensionally in the X-Y plane. New point height is computed by extrapolation of the selected line.

1. Target and measure two points or select an existing line.
2. Activate the CAD tools by a long tap on the line in the sketch area. Select **Point Shift**.



Step	Description
------	-------------

3. Assistant and pop-up ask for the length movement.  
Enter a value and press **OK**.

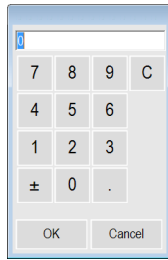

4. The length shifted point is proposed:

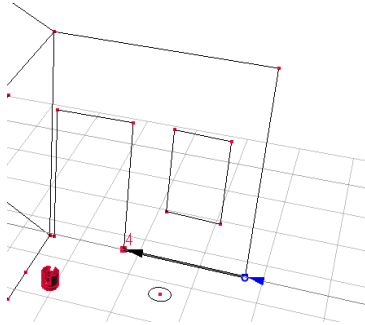

5. Press  to continue.

6. Assistant and pop-up ask for the direction angle for the offset.  
Enter a value and press **OK**.

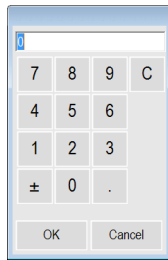

7. The angle for offset direction is proposed:

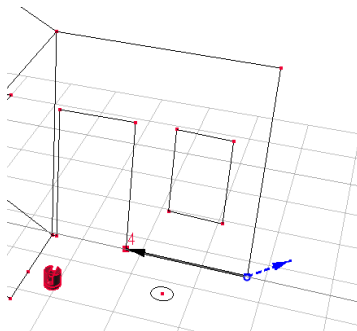

8. Press  to continue.



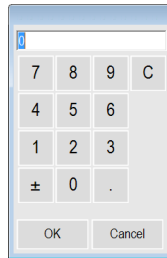

Step	Description
------	-------------

9. Assistant and pop-up ask for the offset.  
Enter a value and press **OK**.

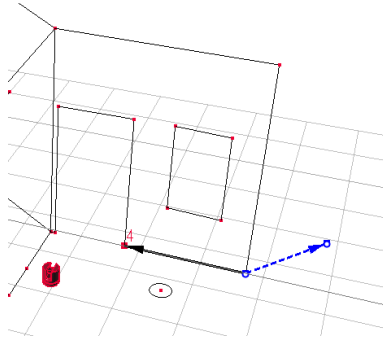

10. The shifted point is proposed:



11. After  was pressed, the new point is generated and the connecting line to the previous point is added.

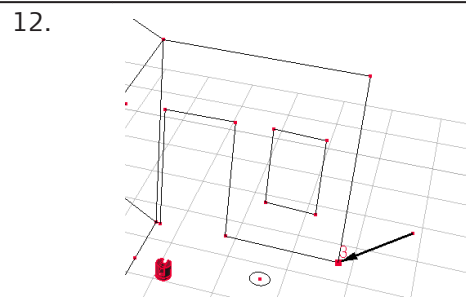

### Perpendicular Inter-section Tool

The **Perpendicular Intersection tool** finds the perpendicular projection of a point on the selected line.

Step	Description
------	-------------



Intersection location is computed two-dimensionally in the X-Y plane. Intersection point height is computed by extrapolation of the first line.

Step	Description
------	-------------

1. Target and measure two points or select an existing line.

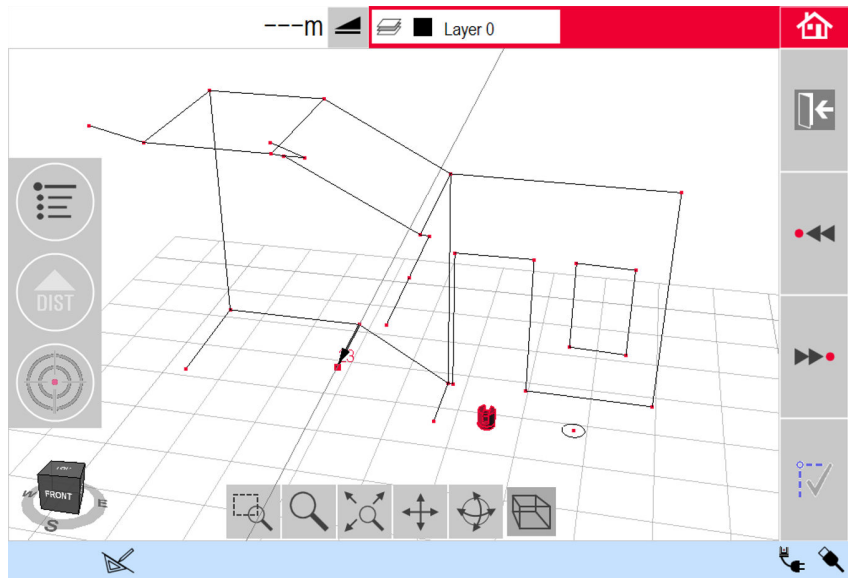



2. Activate the CAD tools by a long tap on the line in the sketch area. Select **Perpendicular Intersection**.

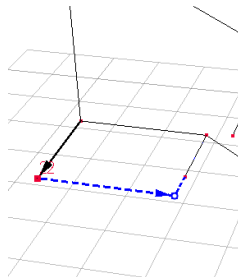

3. The assistant asks for selecting a point. Press **Ok**. Select the point.

4. The intersection point is proposed once a point is chosen:



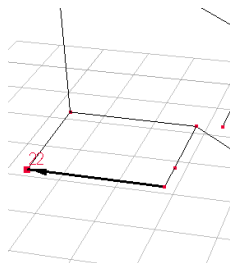

5. After  was pressed, the intersection point is generated and the connecting lines to the existing point were added.

- 6.



## Arc with 3 points Tool

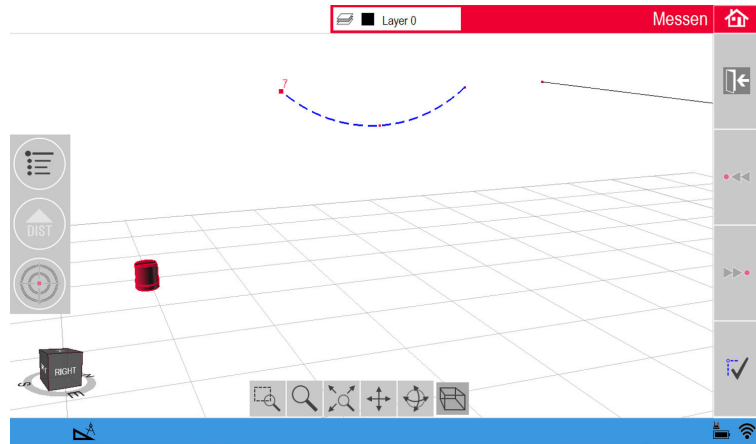

Step	Description
1.	Choose start point of the arc in the sketch area and press  icon to open the CAD tool menu.
2.	Select <b>Arc with 3 points</b> . 
3.	<i>A pop-up prompts for selecting the second point.</i> Select the second point.
4.	<i>Another pop-up prompts for selecting the third point.</i> Select the third point. <i>The arc is proposed once the third point is chosen:</i>

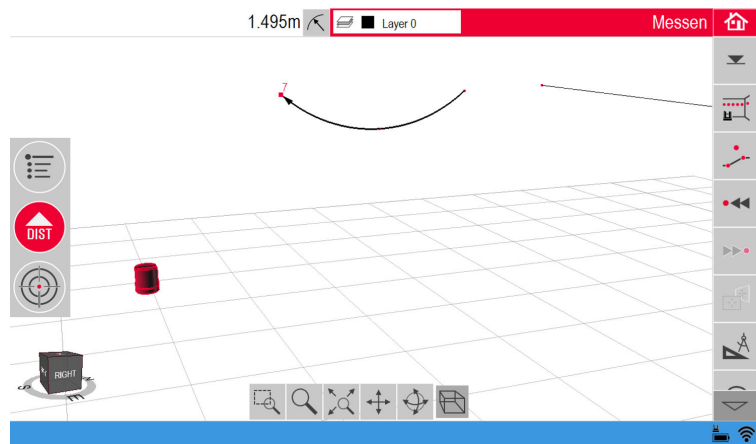

After  was pressed, the arc is generated. The results window contains radius and length of the arc.



## Arc with 2 points and radius Tool

Step	Description
1.	Choose start point of the arc in the sketch area and press  icon to open the CAD tool menu.
2.	Select <b>Arc with 2 points and radius</b> . 

Step	Description
------	-------------

3. *A pop-up prompts to choose the orientation of the arc.*

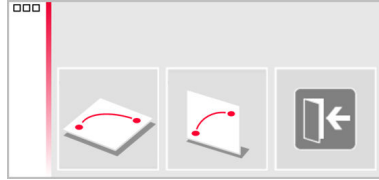

- Horizontal
  - Vertical
- Choose orientation of the arc.

---

4. *Another pop-up prompts for selecting the second point.  
Select the second point.*

---

5. *The pop-up prompts to enter the radius of the arc.*

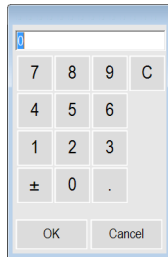

Enter the value and press **OK**.

Step	Description
------	-------------

6. A pop-up prompts to choose the direction of the arc.

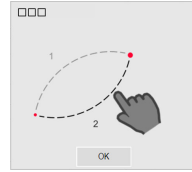

After pressing **OK** the two possible options are proposed.

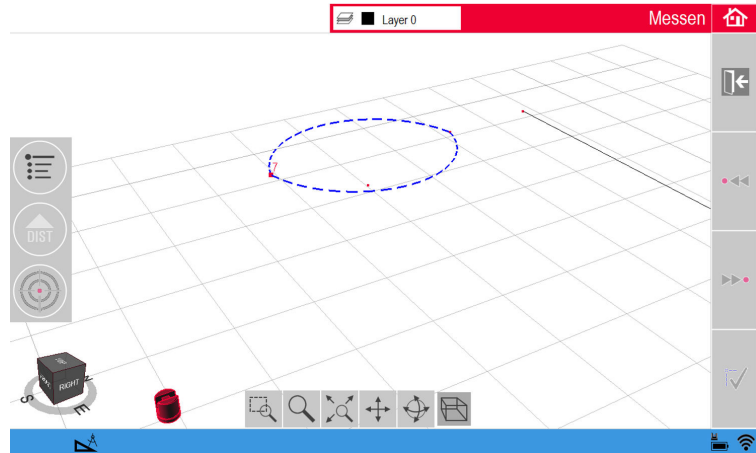

Select on which side the arc shall be drawn by tapping on the relevant segment.

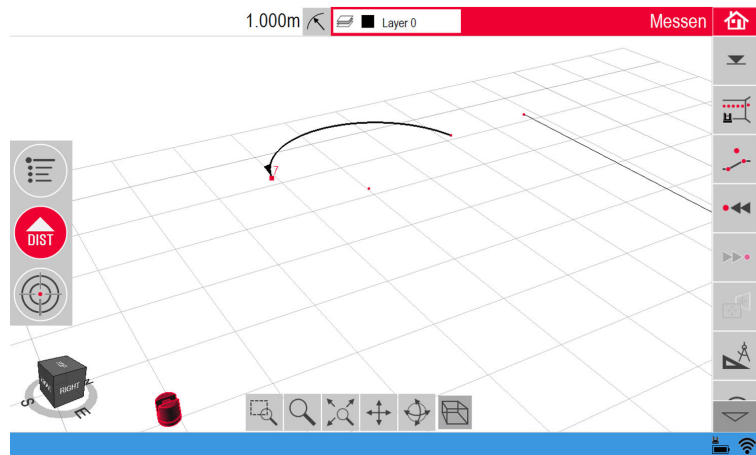

Afterwards the arc is generated. The results window contains radius and length of the arc.

Step	Description
------	-------------

- |    |  |
|----|--|
| 7. | The same workflow applies for the vertical orientation. When the end point of the arc and the radius are defined, two possible options are proposed. |
|----|--|

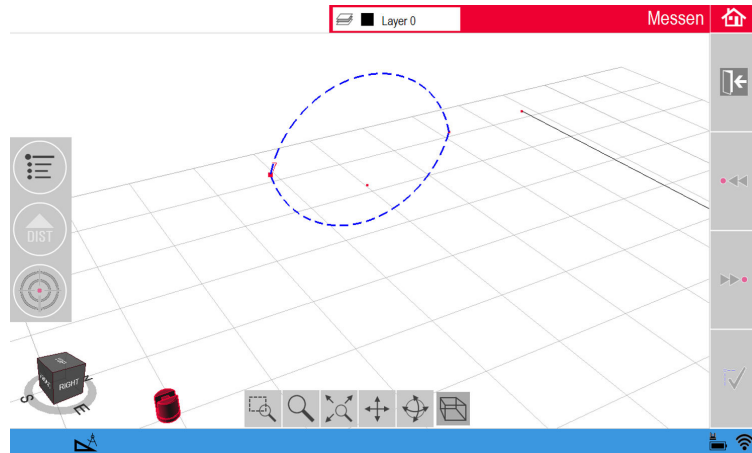

After selecting the side, the arc is drawn in the sketch.

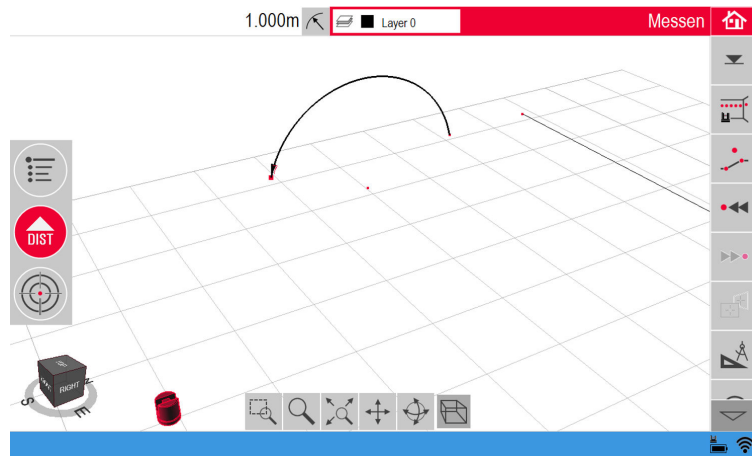

### 6.3

### Projector

#### Description

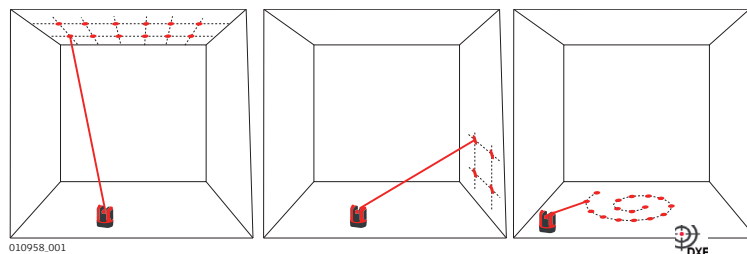

This application projects points or geometrical grids onto a horizontal, vertical or sloped (= "free") plane. Design data in DXF or table format can be imported or a grid's geometry can be entered manually.



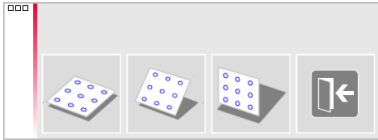

## Projector, Start

Step	Description
1.	Press <b>Menu » Applications » Projector</b> .
2.	 <p>A pop-up offers three scan modes: horizontal, slope and vertical. Select your preference according to the working area.</p>
3.	Pointfinder opens to measure the working area.

## Measure the Working Area

Step	Description
1.	Measure all important objects that you want to consider (edges, corners, etc.).
	For horizontal mode only: the first measured point defines the level that all following points refer to.
2.	If  is enabled, press this key to close the outline. Then measure further points of interest (slope mode only).
3.	When all points are measured, press  to continue.

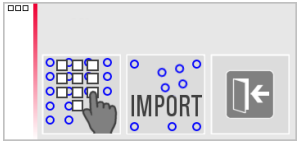
## Point Design

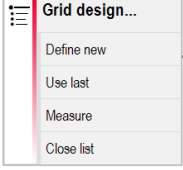

Step	Description
1.	 <p>A pop-up offers two options to define the projection points: Grid mode for a regular pattern and Import mode for individual DXF or CSV files.</p>
	Use the  key at any time to go back to the working area measurement.

## Grid mode

Step	Description
1.	Press  to start Grid mode.
2.	 <p>Pop-up appears to choose between <b>Define new</b>, <b>Use last</b> or <b>Measure</b>.</p>

Step	Description
3.	Select your preferred option: <ul style="list-style-type: none"> <li>• <b>Define new:</b> use the subsequent tools to enter the grid's geometry.</li> <li>• <b>Use last:</b> restore the last grid design that was entered.</li> <li>• <b>Measure:</b> follow the guided workflow to lock onto an existing grid. This option skips the following step <b>Adjustment</b>.</li> </ul>











### Import mode

Step	Description
1.	Press  to start Import mode.
2.	<i>The file manager displays all imported DXF and CSV files. Select a file.</i>
	Press  if you want to check the content via viewer. The head line of the viewer displays the dimension of the file. Change the setting for <b>distance</b> in the menu if the scale does not fit to the working area!
	To import points from a list, enter coordinates X, Y or Y; X in a text editor and save the file with extension CSV. If the import does not work properly check the Import/Export settings in the menu.
3.	Press  to continue.
4.	<i>Projection points are displayed and ready for adjustment.</i>

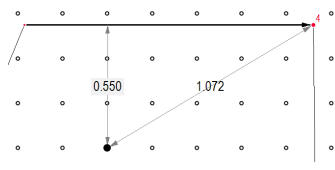



### Design Adjustment



Step	Description
	Use the  key at any time to go back to <b>Point Design</b> .
1.	<b>Aligner</b> opens. <div data-bbox="574 1207 1436 1795" data-label="Image"> </div>
2.	The point design is now displayed in the working area and must be moved to the desired position. Use the following tools:

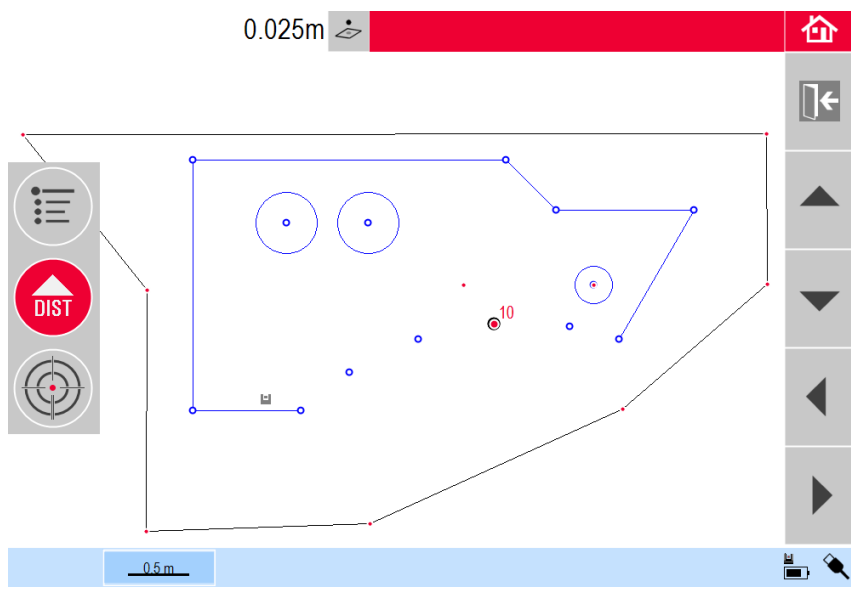

Step	Description
	<p>The grid can be moved up, down, left, and right on the screen in small steps using  /  /  / .</p> <p>The perpendicular distance from a selected grid point to a reference line is displayed. Tap on this distance to enter a value.</p>  <p>Press  to reset the grid position.</p> <p>Press  to align grid parallel to a selected line.</p>
	<p>Lines between design points can be drawn on the screen if necessary before use of the Parallel tool.</p> <p>Press  to turn the grid by 90°.</p> <p>Press  to place the grid exactly on a reference point.</p>
3.	Press  to proceed.

## Point projection

Step	Description
	Press  to go back to the <b>Aligner</b> tool.
1.	<i>In layout mode, the Toolbar changes and you can start to project the grid.</i>
	
2.	Use the arrow keys to select a point and press  . You can also select points by tapping on a point on the screen or by using the remote control.
	Porous, structured or rough surfaces cause problems if the laser beam cannot reflect off the exact position of the layout point.

Step	Description
3.	Laser point flashes if the exact position is found. Point is highlighted in red in sketch area. The result window displays the distance between point and reference plane.
4.	To layout further points select another point and press  .
5.	Press  to save the file.

## Plane Switching



If a point can not be projected on the ceiling, just move the laser beam onto the floor before pressing the **DIST** key. Following points will be projected on the floor from now on. The projection surface can be changed at any time.

### 6.3.2

## Targeting and Layout with RM100 Remote Control

### Functionality of the keys in Projector application



Press  to activate laser and a second time to project or measure a point within the reference area.



Each arrow key selects the neighbouring point, turns the 3D Disto and starts the iterative measurement. Press once to activate the remote control and a second time to execute the command.

### 6.4

## Location



### Description

The **Location** functions allow to change the position of the 3D Disto.

**Secure Points** are placed by the user and make the positioning procedure easy.

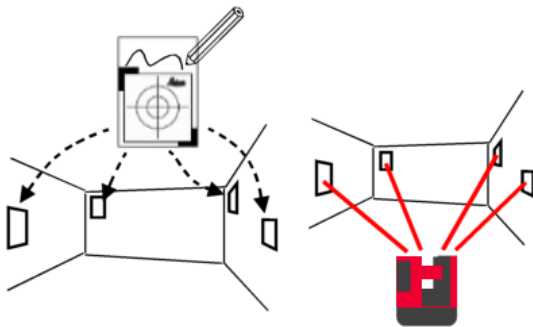

### Secure Location step-by-step



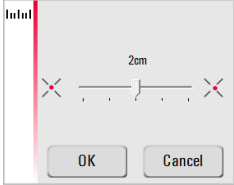

Step	Description
	You have to measure two points first before <b>Secure Points</b> can be saved.
1.	Label and affix three to five self-adhesive target marks on walls, ceiling or floor around your working area. Ensure that the target marks are spread out.
	
2.	Press <b>Menu » Applications » Location » Secure Location</b> . <i>Pointfinder opens.</i>

Step	Description
3.	Target the <b>Target marks</b> as precisely as possible and press  to measure. <i>3D Disto takes a photo and saves it with coordinates, labelled with ID and date.</i>
4.	Pop-up prompts <b>Measure more Secure Points? Yes/No.</b>
5.	Proceed as before and measure at least three Secure Points.
	You can add more Secure Points at any time.
	Ensure you have enough well-measured Secure Points around your working area. Even if one is lost there must be at least three for a successful relocation.
6.	After saving a minimum of three points you may leave the application by choosing <b>No</b> .

### Relocation step-by-step



This feature allows the relocation of the 3D Disto into a defined coordinate system previously established by the **Secure Location** procedure, for example to complete a previous measurement.

Step	Description
	Use a 3D Disto position that allows targeting and measuring at least three Secure Points around your working area.
1.	Press <b>Menu » Applications » Location » Relocate</b> .
2.	<i>A pop-up prompts you to define the tolerance.</i>
	
	Press <b>OK</b> to confirm the value.
	A lower tolerance increases the accuracy of your measurements and requires precise aiming and visibility of the Secure Points.
	If there are no Secure Points available but your measurement must fit to the geometry of a previous one, just start your measurement with the same Base Line points. These are the first two points of a measurement.

Step	Description
3.	<p>If Secure Points are available, folder opens.</p>  <p>Choose a Secure Point by pressing ◀ / ▶ or by tapping on the screen.</p> <p>Press 👁 to enlarge.</p> <p>Press 📄 to see all Secure Points of the whole memory.</p>
4.	<p>Press ✓ to confirm point. <i>Pointfinder opens.</i></p>
5.	<p>Target the target mark shown in the photo as precisely as possible and press  to measure. If successful, pop-up appears <b>Measure next Secure Point? Yes/Cancel.</b></p>
6.	<p>If <b>Yes</b>: Folder opens to choose next Secure Point. Proceed as described previously for the second and third Secure Point.</p>
	<p>If the first two Secure Points were measured successfully the 3D Disto roughly turns to the next chosen Secure Point. You just have to do the fine targeting and press .</p>
7.	<p>When you have measured three points successfully a pop-up shows <b>OK. Measure more Secure Points? Yes/No/Cancel.</b></p> <ul style="list-style-type: none"> <li>• Press <b>Yes</b> to continue and proceed as described previously.</li> <li>• Press <b>No</b> to finish. If successful, a pop-up displays the dimensions between old and new position: <b>XXXm; Height: XXXm; OK/Cancel.</b> Accept with <b>OK</b> or <b>Cancel</b> to measure further points.</li> </ul> <p>If Relocation was not successful, pop-up prompts <b>Out of tolerance! Measure more Secure Points? Yes/No/Cancel.</b> Go on as described previously.</p>
8.	<p>Press  to close the application.</p>

### Location Check step-by-step

If the 3D Disto was unintentionally moved, for example got bumped, the geometry of the measured points will no longer fit with that of the previously measured points. Start a Location Check to sustain the current accuracy/geometry.

Step	Description
1.	To initiate a Location Check press <b>Menu » Applications » Location » Check Location</b> .
2.	If Secure Points are available, select Secure Point and press  .
3.	<i>The 3D Disto will target the Secure Point automatically.</i> Check laser point position with target mark.  If the laser point does not target the centre of the target mark, a relocation is recommended.
4.	Proceed that way for checking further points.
5.	Press  to close <b>Secure Point</b> gallery.

## 6.5

### Tool Kit

#### General

In addition to the standard applications this program features:

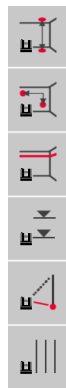

- Comfort Plumbing,
- Comfort Targeting,
- Comfort Level,
- Meter Mark,
- Height Tracking, and
- Parallel Line.

After each layout task the respective tool has to be restarted. A pop-up offers to continue with the same reference or to measure a new one. Data is not stored and cannot be imported or exported. Remote Control functionality is not supported in these applications.

#### 6.5.1



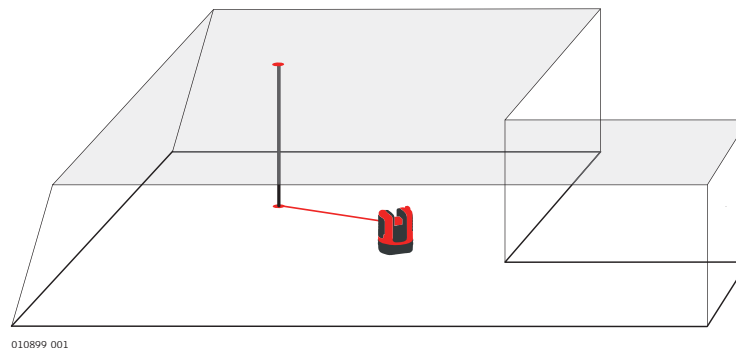

### Comfort Plumbing

#### Description

**Comfort Plumbing** allows plumbing any point up or down without standing above it.



## Comfort plumbing step-by-step

Step	Description
1.	Start application in <b>Menu » Applications » Tool Kit</b> . The running application stays open in the background.
2.	Press  on the Toolbar. <i>Pointfinder opens.</i>
3.	Target and measure the point to be plumbed. Press  . <i>Pointfinder stays open.</i>
4.	Roughly target expected plumb and press  . <i>If plumb is found the laser flashes to indicate the exact position.</i>
5.	Press  to close Tool Kit.

### 6.5.2

### Comfort Targeting

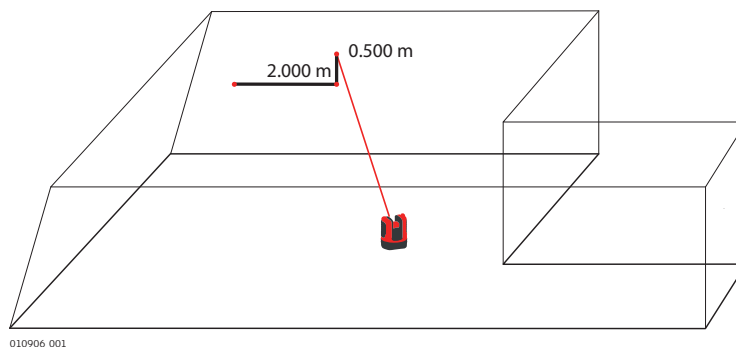

#### Description

**Comfort Targeting** allows laying out a point relative to a reference point on vertical surfaces.



Use this tool only on vertical surfaces. On tilted surfaces, the layout position will not be correct.

#### Comfort targeting step-by-step

Step	Description
1.	Start application in <b>Menu » Applications » Tool Kit</b> . The running application stays open in the background.
2.	Press  on the toolbar. <i>Pointfinder opens.</i>
3.	Target reference point on the wall. Press  .
4.	<i>Pop-up prompts to enter value for left or right distance to reference point. For left turn set a negative value. Enter 0 to lay out points with only vertical offsets to the reference point. Press <b>OK</b> to confirm the value. Laser point flashes to indicate exact position.</i>
5.	<i>Pop-up appears to enter vertical value (= distance above/below layout point). Default value = 0. Set a negative value for down turn. Press <b>OK</b> to confirm the value. 3D Disto turns and lays out the correct position. Laser point flashes to indicate exact position.</i>

Step	Description
6.	Press  to close Tool Kit.

### 6.5.3



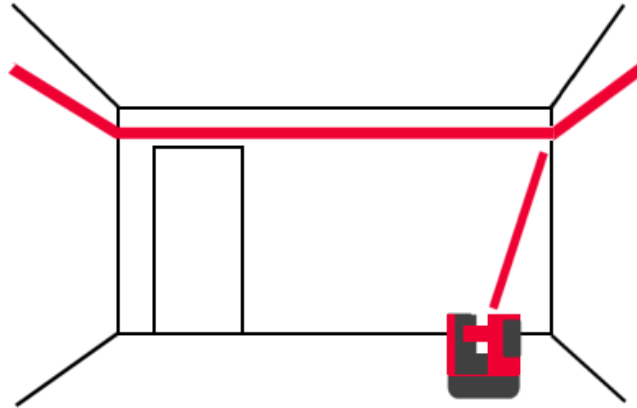

#### Comfort Level

##### Description

**Comfort levelling** keeps the laser point at the same level when you turn the 3D Disto horizontally.



##### Comfort levelling step-by-step

Step	Description
1.	Start application in <b>Menu » Applications » Tool Kit</b> . The running application stays open in the background.
2.	Press  on the toolbar. <i>Pointfinder opens.</i>
3.	Target reference height on the wall. Press  . <i>Pointfinder stays open.</i>
4.	Roughly target the assumed layout point and press  . <i>Laser point flashes to indicate exact height position.</i>
5.	Press  to close Tool Kit.

### 6.5.4

#### Meter Mark



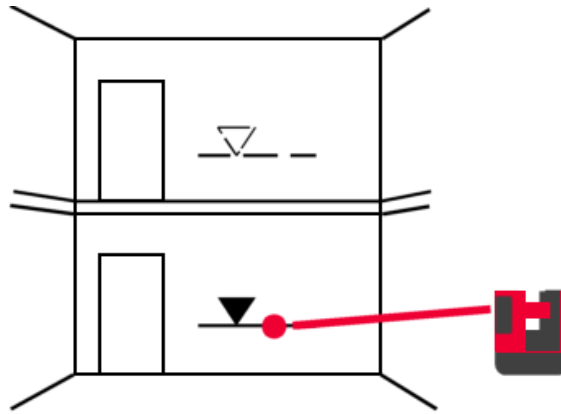

##### Description

The **Meter Mark** tool refers to a meter mark or reference height and allows laying out any desired height.

This tool can be very helpful to mark the meter mark at several places in a room or lay out heights on several building levels.



### Meter mark step-by-step

Step	Description
1.	Start application in <b>Menu » Applications » Tool Kit</b> . The running application stays open in the background.
2.	Press  on the toolbar.
3.	<i>Pop-up prompts to enter the height and measure that reference height.</i>
4.	<i>Pointfinder opens.</i> Target reference point on the wall. Press  .
5.	<i>Pop-up prompts to enter an absolute height to be laid out.</i>
6.	<i>Pointfinder opens.</i> Roughly target close to expected absolute height on the wall. Press  <i>Laser point flashes to indicate exact position of the absolute height.</i>
7.	Press  to close Tool Kit.

### 6.5.5

### Height Tracking

#### Description

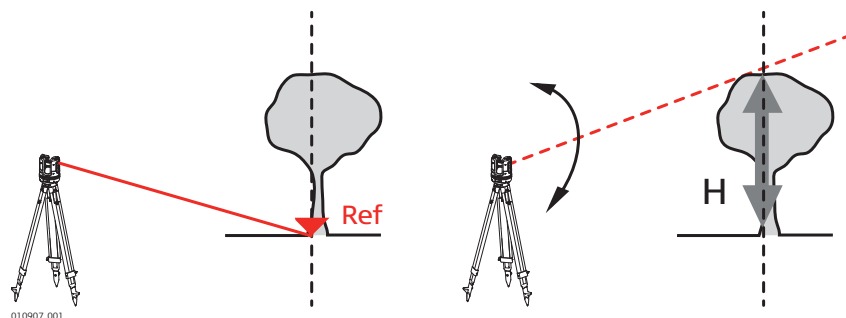

**Height Tracking** allows determination of the height of a target that cannot be measured directly.

This tool can be very helpful for measuring the height of a tree or of power lines.





## Height tracking step-by-step

Step	Description
1.	Start Application in <b>Menu » Applications » Tool Kit</b> . The running application stays open in the background.
2.	Press  on the toolbar. <i>Pointfinder opens.</i>
3.	Target and measure a reference point at the same horizontal distance as the point you would like to measure indirectly. <i>Pointfinder stays open and measured point is displayed.</i>
	Do not move the 3D Disto horizontally too much after reference point has been measured, otherwise the result will be incorrect.
4.	Target the point you would like to measure indirectly as exact as possible. <i>The height difference to the reference point is displayed and updated in real-time in the results window.</i>
5.	Close the Pointfinder to finish the application.

### 6.5.6



#### Parallel Line

##### Description

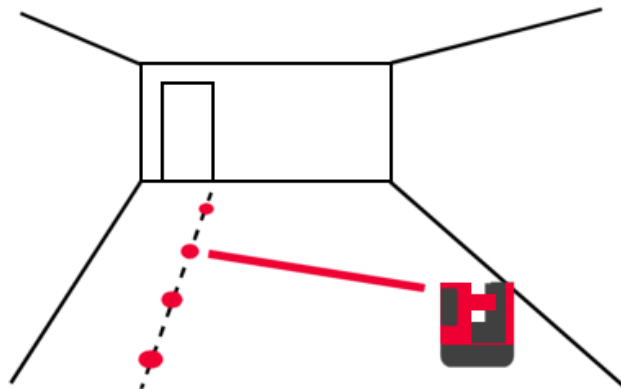
**Parallel line** allows laying out lines parallel to a reference line on walls, floors, or tilted surfaces.



## Parallel Line step-by-step

Step	Description
1.	Start application in <b>Menu » Applications » Tool Kit</b> . The running application stays open in the background.
2.	Press  on the toolbar. <i>Pointfinder opens.</i>
	All points have to be measured on the same surface.
3.	Target and measure start and end point of the reference line.
4.	A pop-up prompts to enter parallel distance to the left or right of the reference line. Press <b>OK</b> to confirm the entered value.
5.	<i>Pointfinder opens to roughly target layout point.</i> Press  . <i>Laser point flashes to indicate the exact position on the parallel.</i>

Step	Description
6.	Press  to close Tool Kit.

## 7

## Error Messages

### Error messages and advice

Error No.	Advice
150	Working range was exceeded.
151	Invalid measurement.
152	Change the 3D Disto position or use ruler for offset points.
153	Radius too small for chosen points! Increase radius.
160	Repeat and do not move the ruler between both measurements.
161	In some cases the Offset Point tool can not be used.
170	Restart 3D Disto if the problem persists.
171	Check all devices, for example power supply or cables, and try again.
240	Tilt sensor calibration was not successful. System accuracy is at risk. Contact your distributor or Leica Geosystems representative.
241	Too much drift. Repeat calibration precisely.
243	Set up the instrument stably. Do not touch or rotate the 3D Disto. Repeat calibration.
300	Select a horizontal line.
350	Check projection surface. Laser could not reach the correct position.
755	Point cannot be measured. Try different position. Tool does not work on horizontal planes.
760	Point cannot be measured. Enter different values. Tool does not work on horizontal planes.
765	Point cannot be measured. Try different position or enter different value. Tool does not work on horizontal planes.
800	Data import or export is not possible.
801	Not enough memory on USB stick.
802	Storage device does not work properly.
803	Check file condition and content.
804	File or Folder write-protected or damaged.
900	3D Disto error. Contact your distributor or Leica Geosystems representative if the error repeats.
901	The reflected laser signal is too low.
902	The reflected laser signal is too high.
903	Too much background light.
904	Laser beam interrupted. Repeat measurement.
950	Execute Location Check to retain accuracy!
951	3D Disto tilt is over 3°. Set up horizontally!
953	Check connection and cable.
954	Plug in cable or choose "WLAN" in the menu.

<b>Error No.</b>	<b>Advice</b>
955	3D Disto temperature out of working range.
956	Too much vibration or permanent movement.
998	Contact your distributor or Leica Geosystems representative.
999	Contact your distributor or Leica Geosystems representative.

## 8

## Check & Adjust

### 8.1

### Overview

#### Description

Leica Geosystems instruments are manufactured, assembled and adjusted to the best possible quality. Quick temperature changes, shock or stress can cause deviations and decrease the instrument accuracy. It is therefore recommended to check and adjust the instrument from time to time. This check and adjust can be done in the field by running through specific measurement procedures. The procedures are guided and must be followed carefully and precisely as described in the following chapters. Some other instrument errors and mechanical parts can be adjusted mechanically.

#### Electronic adjustment

The following instrument errors can be checked and adjusted electronically:

- Crosshairs offset
- V-index
- Tilt sensor

 All calibration settings can also be reset to factory default.



During the manufacturing process, the instrument errors are carefully determined and set to zero. As mentioned previously, these errors can change and it is highly recommended to redetermine them in the following situations:

- After rough or long transportation
- After long storage periods
- If the temperature difference between the current environment and at the last calibration is more than 20°C

### 8.2

### Tilt Sensor Calibration

#### Description

#### Before Calibration:

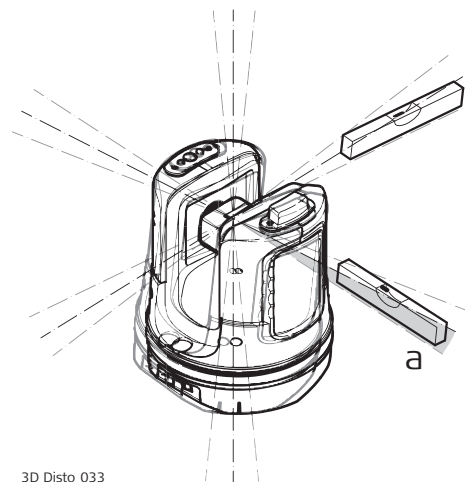

a Tilt sensor offset

#### After Calibration:

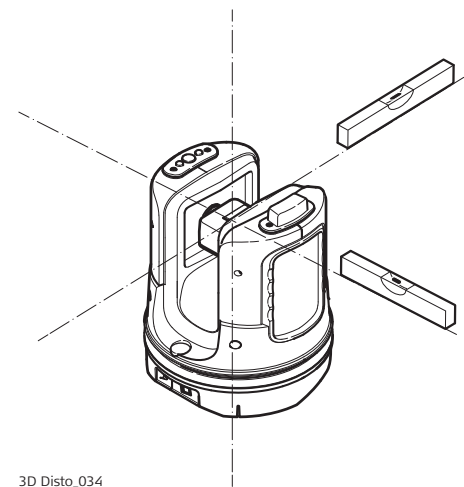



#### Adjustment step-by-step

Step	Description
------	-------------

 This calibration is done automatically. You must only ensure that the 3D Disto is set up < 3°.

1. Calibration is started in **Menu » Device » Calibration**.

Step	Description
2.	Press  .
3.	<i>3D Disto starts self-levelling automatically: the tilt is checked and the instrument levels itself if the tilt is <math>&lt; 3^\circ</math>.</i>
	Pop-up prompts <b>Don't touch 3D Disto about 1 minute!</b>
4.	If <b>ok</b> , pop-up prompts <b>Calibration successful.</b>

### 8.3

### Crosshairs Offset

#### Description

The laser point and the crosshairs in the Pointfinder do not coincide.

#### Before Calibration:

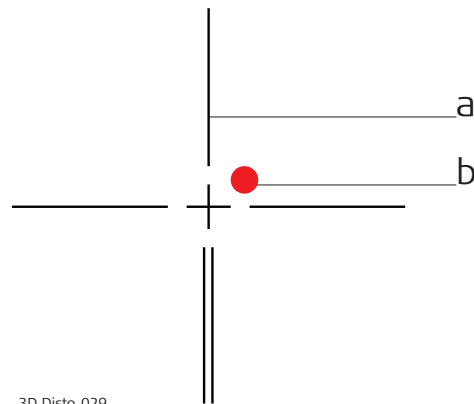

3D Disto\_029

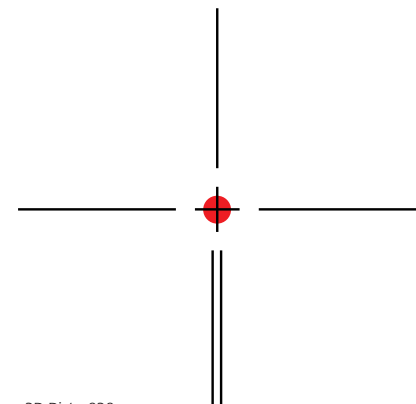

#### After Calibration:



3D Disto\_030

- a Crosshairs
- b Laser point

#### Adjustment step-by-step

Step	Description
1.	Calibration is started in <b>Menu » Device » Calibration.</b>
2.	Press  .
3.	<i>Pointfinder opens.</i> Place a target mark at a distance $> 25$ m.
4.	Now aim at the target mark as precisely as possible. Press  when the red laser spot is exactly on the target.
5.	<i>Pointfinder stays open and red crosshairs are displayed.</i> Move crosshairs to the centre of target mark as precisely as possible with the arrow keys. Press  again.
6.	If in tolerance, pop-up appears with <b>Set new: x=...px; y=...px, Reset to factory default, or Cancel calibration.</b>
7.	Choose <b>Set...</b> or <b>Reset...</b> to adjust crosshairs. Final pop-up asks <b>Are you sure? Yes/Cancel.</b>
8.	If <b>Yes</b> , checkmark is displayed to confirm parameters were set successfully.

## 8.4

## V-Index Error

### Description

The vertical index does not coincide with the standing axis.



Tilt sensor calibration followed by a crosshairs calibration is recommended before starting V-Index calibration! Refer to [8.2 Tilt Sensor Calibration](#) and [8.3 Crosshairs Offset](#).

#### Before Calibration:

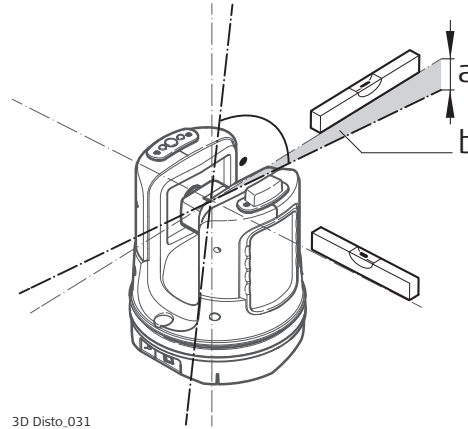

#### After Calibration:

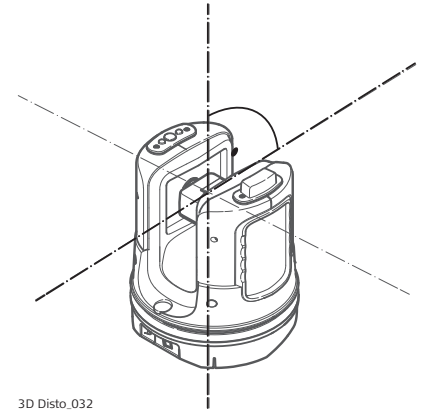

- a Height error
- b Vertical angle offset

### Adjustment step-by-step

Step	Description
------	-------------

- |    |  |
|----|--|
| 1. | Set up the 3D Disto close to a wall with a steep target of good visibility that is at least 15 m above the instrument. |
|----|--|

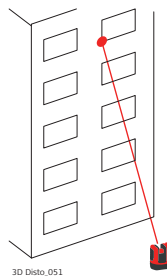

- |    |   |
|----|---|
| 2. | Calibration is started in <b>Menu » Device » Calibration</b> .  |
| 3. | Press  .  |
| 4. | <i>Pointfinder opens.</i><br>Target as precisely as possible.   |
| 5. | Press  .  |
| 6. | <i>3D Disto turns to second face automatically.</i><br><br>Target a second time. Press  .   |
| 7. | If both measurements were successful, a pop-up window appears with <b>Set new: XXX gon, Reset to factory default, or Cancel calibration</b> . |
| 8. | Choose <b>Set...</b> or <b>Reset...</b> to adjust V-index.  |

Step	Description
9.	Final pop-up asks <b>Are you sure? Yes/Cancel</b> . If <b>Yes</b> , checkmark is displayed to confirm parameters were set successfully.

## 8.5

### Reset to factory settings step-by-step

### Reset to Factory Settings

Step	Description
1.	Calibration is started in <b>Menu » Device » Calibration</b> .
2.	Press  . Pop-up appears <b>Reset all calibration settings to factory default? Yes/No</b> .
3.	If <b>Yes</b> : all user-defined calibration settings are reset to factory default without further request.



## 9

# Instrument Protection (Theft Protection)

### Description

The instrument can be protected by a **Personal Identification Number**. If the PIN protection is activated, the software will always prompt for a PIN code entry after starting up.

If the wrong PIN was entered three times, a PUK is required, which can be found on the instrument delivery papers. If the PUK code was entered correctly, the PIN code is set to default value "0" and the PIN protection is deactivated.

Contact your Leica Geosystems representative if you need a replacement PUK.

### Activate PIN code step-by-step

Step	Description
1.	Got to <b>Menu » Device » Theft protection</b> . Default setting is <b>Off</b> .
2.	Press <b>Enable</b> to activate.
3.	Enter your desired PIN code (3 to 8 character numeric or alpha).
4.	Accept with <b>Ok</b> .
	Now the instrument is protected against unauthorised use. The PIN code is required now after switching on the instrument, de-activating standby, or re-entering the PIN settings.

### Deactivate PIN code step-by-step

Step	Description
1.	Got to <b>Menu » » Theft protection.Device</b> Press <b>Disable</b> to deactivate.
2.	Enter your PIN code and press <b>OK</b> to accept.
	The instrument is no longer protected against unauthorised use.

## 10 Care and Transport

---

### 10.1 Transport

---

<b>Transport in the field</b>	<p>When transporting the equipment in the field, always make sure that you</p> <ul style="list-style-type: none"><li>• either carry the product in its original container,</li><li>• or carry the tripod with its legs splayed across your shoulder, keeping the attached product upright.</li></ul>
<b>Transport in a road vehicle</b>	<p>Never carry the product loose in a road vehicle, as it can be affected by shock and vibration. Always carry the product in its container and secure it.</p> <p>For products for which no container is available use the original packaging or its equivalent.</p>
<b>Shipping</b>	<p>When transporting the product by rail, air or sea, always use the complete original Leica Geosystems packaging, container and cardboard box, or its equivalent, to protect against shock and vibration.</p>
<b>Shipping, transport of batteries</b>	<p>When transporting or shipping batteries, the person responsible for the product must ensure that the applicable national and international rules and regulations are observed. Before transportation or shipping, contact your local passenger or freight transport company.</p>
<b>Field adjustment</b>	<p>Exposing the product to high mechanical forces, for example through frequent transport or rough handling, or storing the product for a long time may cause deviations and a decrease in the measurement accuracy. Periodically carry out test measurements and perform the field adjustments indicated in the User Manual before using the product.</p>

---

### 10.2 Storage

---

<b>Product</b>	<p>Respect the temperature limits when storing the equipment, particularly in summer if the equipment is inside a vehicle. Refer to <a href="#">11 Technical Data</a> for information about temperature limits.</p>
<b>Li-Ion batteries</b>	<ul style="list-style-type: none"><li>• Refer to <a href="#">11 Technical Data</a> for information about storage temperature range.</li><li>• Remove batteries from the product and the charger before storing.</li><li>• After storage recharge batteries before using.</li><li>• Protect batteries from damp and wetness. Wet or damp batteries must be dried before storing or use.</li><li>• A storage temperature range of 0 °C to +30 °C / +32 °F to +86 °F in a dry environment is recommended to minimize self-discharging of the battery.</li><li>• At the recommended storage temperature range, batteries containing a 40% to 50% charge can be stored for up to one year. After this storage period the batteries must be recharged.</li></ul>

---

## 10.3

## Cleaning and Drying

---

### Housing and Optical Components

- Blow dust off housing and optical components such as lenses or windows.
  - Never touch the glass with your fingers.
  - Use only a clean, soft, lint-free cloth for cleaning. If necessary, moisten the cloth with water or pure alcohol. Do not use other liquids; these may attack the polymer components.
- 

### Damp products

Dry the product, the transport container, the foam inserts and the accessories at a temperature not greater than 40°C/104°F and clean them. Do not repack until everything is dry. Always close the transport container when using in the field.

---

### Cables and plugs

Keep plugs clean and dry. Blow away any dirt lodged in the plugs of the connecting cables.

---

# 11

## Technical Data

### 11.1

#### Technical Data

Accuracy Tie Distance (3D)	at 10 m	at 30 m	at 50 m
	Combination of angle and distance measurement	ca. 1 mm	ca. 2 mm

---

Angle Measurement (Hz/V)	Working range:	Horizontal 360°, Vertical 250°
	Accuracy	5" (1.2 mm at 50 m)

---

Characteristics laser distance meter	Type:	Coaxial, visible red laser
	Working range:	0.5 m - 50 m
	Laser class:	2
	Laser point size (at 10 m):	~7 mm × 7 mm
	Laser point size (at 30 m):	~9 mm × 15 mm

---

Tilt Sensor	Self-levelling range:	± 3°
	Accuracy:	10" (2.5 mm at 50 m)

---

Pointfinder	Zoom (Magnification):	1×, 2×, 4×, 8×	
	Field of view (at 10 m):	1×:	3.40 m × 2.14 m
		2×:	1.70 m × 1.07 m
		4×:	0.85 m × 0.54 m
8×:		0.42 m × 0.27 m	

---

Circular bubble sensitivity	1°/mm
-----------------------------	-------

---

Operation	Buttons:	ON/OFF Button
	Ports:	USB Type B, power supply plug-in

---

Communication	Data transfer:	USB Type A, WLAN
	Wireless technology:	WLAN
		Range: 50 m (depending on the environment)
Power: 87 mW		
Supported data formats:	Frequency: 2412 MHz - 2472 MHz	
	Channels: 1 - 11	
	Import: DXF, CSV	
Export: DXF, TXT, CSV, JPG, DWG		

<b>Power</b>	<b>Internal:</b>	
	Type:	Li-Ion battery
	Voltage:	14.4 V, 63 Wh
	Charging time:	8 h
	Typical operating time	8 h
	<b>External:</b>	
	Voltage:	24 VDC, 2.5 A
<b>Mounting</b>	5/8" thread	
<b>Instrument dimensions</b>	186.6 mm × 215.5 mm (diameter × height)	
<b>Weight</b>	2.8 kg	
<b>Environmental specifications</b>	<b>Temperature</b>	
	Operating temperature:	-10°C to +50°C
	Storage temperature:	-25°C to +70°C
	<b>Protection against dust, sand and water</b>	
	IP54 (IEC60529)	
	<b>Humidity</b>	
	Protection:	Max 85 % r.h. non-condensing
<b>RM100 Remote Control</b>	Range:	30 m (depending on environment and operation conditions)
	Communication:	Infrared (IR)
	Battery	1 AA, 1.5 V

## 11.2

### Conformity to National Regulations

#### Conformity to national regulations

- FCC Part 15, 22 and 24 (applicable in US).
- Hereby, Leica Geosystems AG, declares that the 3D Disto and the RM100 are in compliance with the essential requirements and other relevant provisions of Directive 2014/53/EU and other applicable European Directives.

The full text of the EU declaration of conformity is available at the following Internet address: <http://www.leica-geosystems.com/ce>.



Class 1 equipment according to European Directive 2014/53/EU (RED) can be placed on the market and be put into service without restrictions in any EEA member state.

- The conformity for countries with other national regulations not covered by the FCC part 15, 22 and 24 or European Directive 2014/53/EU (RED) has to be approved prior to use and operation.

- Japanese Radio Law and Japanese Telecommunications Business Law Compliance.
  - This device is granted pursuant to the Japanese Radio Law (電波法) and the Japanese Telecommunications Business Law (電気通信事業法).
  - This device should not be modified (otherwise the granted designation number will become invalid).

---

## 11.3

### Dangerous Goods Regulations

---

### Dangerous Goods Regulations

---

Many products of Leica Geosystems are powered by Lithium batteries.

Lithium batteries can be dangerous under certain conditions and can pose a safety hazard. In certain conditions, Lithium batteries can overheat and ignite.



When carrying or shipping your Leica product with Lithium batteries onboard a commercial aircraft, you must do so in accordance with the **IATA Dangerous Goods Regulations**.



Leica Geosystems has developed **Guidelines** on "How to carry Leica products" and "How to ship Leica products" with Lithium batteries. Before any transportation of a Leica product, we ask you to consult these guidelines on our web page (<http://www.leica-geosystems.com/dgr>) to ensure that you are in accordance with the IATA Dangerous Goods Regulations and that the Leica products can be transported correctly.



Damaged or defective batteries are prohibited from being carried or transported onboard any aircraft. Therefore, ensure that the condition of any battery is safe for transportation.

---

**Description****International Limited Warranty**

The Leica 3D Disto comes with a two year warranty from Leica Geosystems AG. To receive an additional year warranty, the product must be registered on our website at [www.disto.com/warranty](http://www.disto.com/warranty) within eight weeks of the purchase date. If the product is not registered, our two year warranty applies.

More detailed information about the International Limited Warranty can be found on the internet at:

[www.leica-geosystems.com/internationalwarranty](http://www.leica-geosystems.com/internationalwarranty)

---

**Software Licence Agreement**

This product contains software that is preinstalled on the product, or that is supplied to you on a data carrier medium, or that can be downloaded by you online according to prior authorisation from Leica Geosystems. Such software is protected by copyright and other laws and its use is defined and regulated by the Leica Geosystems Software Licence Agreement, which covers aspects such as, but not limited to, Scope of the Licence, Warranty, Intellectual Property Rights, Limitation of Liability, Exclusion of other Assurances, Governing Law and Place of Jurisdiction. Please make sure, that at any time you fully comply with the terms and conditions of the Leica Geosystems Software Licence Agreement.

Such agreement is provided together with all products and can also be referred to and downloaded at the Leica Geosystems home page at <http://leica-geosystems.com/about-us/compliance-standards/legal-documents> or collected from your Leica Geosystems distributor.

You must not install or use the software unless you have read and accepted the terms and conditions of the Leica Geosystems Software Licence Agreement. Installation or use of the software or any part thereof, is deemed to be an acceptance of all the terms and conditions of such Licence Agreement. If you do not agree to all or some of the terms of such Licence Agreement, you must not download, install or use the software and you must return the unused software together with its accompanying documentation and the purchase receipt to the distributor from whom you purchased the product within ten (10) days of purchase to obtain a full refund of the purchase price.

---

**GNU Public Licence**

Parts of the 3D Disto software are developed under GPL (GNU public licence). The corresponding licences can be found on the Leica USB memory stick in the directory "GPL licences".

If you need more information, contact a Leica Geosystems representative. You can find contact details at [www.leica-geosystems.com/contacts](http://www.leica-geosystems.com/contacts).

---

**Google Analytics**

The Leica 3D Disto software for Windows® stores support related information and usage statistics on your computer (that is, usage of software tools, number of measurements, analysis of measuring ranges and so on).

Leica Geosystems uses Google Analytics, a web analytics service provided by Google Inc. to analyse this information. Leica Geosystems does not process nor store any personal data or other customer-related data such as serial number of the Leica 3D Disto or the IP address of the user.

---







**847903-6.1.0en**

Original text (847903en-6.1.0)

Printed in Switzerland

© 2020 Leica Geosystems AG, Heerbrugg, Switzerland



- when it has to be **right**



**Leica Geosystems AG**  
Heinrich-Wild-Strasse  
CH-9435 Heerbrugg  
Switzerland  
Phone +41 71 727 31 31  
[www.leica-geosystems.com](http://www.leica-geosystems.com)

